

**SUNMORE®**

GERMANY STANDARD  
CARBIDE TIPPED SAW

# AN BINH SAW BLADE CO., LTD



**CÔNG TY TNHH LƯỠI CỬA AN BÌNH**

Đ/C: 14, An Phú 35, Bình Chuẩn, Thuận An, Bình Dương

Tel: 0274-3764494 - 098 210 9076 - 098 977 1232

Email: [anbinhsaw@gmail.com](mailto:anbinhsaw@gmail.com)

Website: [www.sunmore.com.vn](http://www.sunmore.com.vn) - [www.luoicuasunmore.com.vn](http://www.luoicuasunmore.com.vn)





Φ205 x 4.0 x 48 x 40

SUNMORE



180 X 4.3/5.8 X 45 X 36

SUNMORE



120 X 4.0 X 25.4 X 24

SUNMORE



180 X 1.8 X 60 X 24

SUNMORE



400 X 4.4 X 60 X 72

SUNMORE



400 x 4.4 x 60 x 72

SUNMORE



455 x 4.0 x 70 x 72

SUNMORE



Φ405 x 4.0 x 25.4 x 120

SUNMORE



355 x 3.5 x 30 x 72

SUNMORE



400 x 4.4 x 60 x 72

SUNMORE



Φ350 x 3.5 x 30 x 108

SUNMORE



Φ305 x 3.0 x 25.4 x 48

SUNMORE



355 x 3,6 x 55 x 36 : 4

SUNMORE



305 x 3.0 x 25.4 x 120

SUNMORE



300 x 3.2 x 30 x 96

SUNMORE





 P050 p. 387	 P053 p. 388	 P054 p. 389	 P056 p. 390	 P057 p. 391	 P058 p. 392	 P059 p. 393
 P060 p. 394	 P062 p. 395	 P064 p. 396	 P066 p. 397	 P067 p. 398	 P068 p. 399	 P069 p. 401
 P070 p. 402	 P071 p. 403	 P072 p. 404	 P080 p. 405	 P400 p. 406	 P401 p. 407	 P094 p. 408
 P095 p. 409	 P100 p. 410	 P104 p. 411	 P105 p. 412	 P107 p. 413	 P108 p. 414-415	 P109 p. 416
 P111 p. 417	 P410 p. 418	 P610 p. 419	 P618 p. 420	 P620 p. 421	 P414 p. 422	 P614 p. 423
 P118 p. 424	 P127 p. 425	 P120 p. 426	 P122 p. 427	 P124 p. 428	 P121 p. 429	 P123 p. 430
 P125 p. 431	 P134 p. 432	 P136 p. 433	 P140 p. 434	 P160 p. 435	 P560 p. 436	 P562 p. 437
 P170 p. 438	 P172 p. 439	 P185 p. 440	 P351 p. 441	 P381-P383 p. 442	 P385 p. 443	 PCB1-PCB2

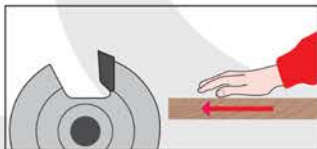
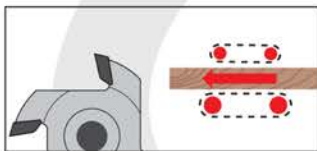
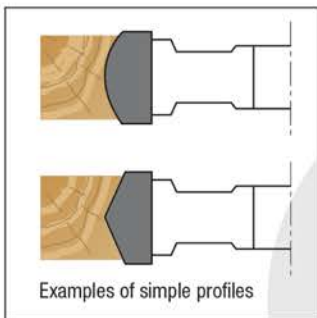
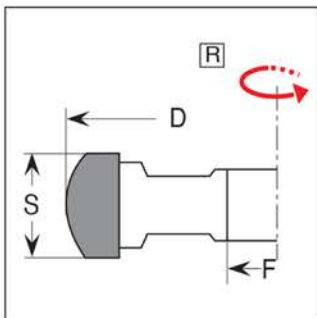
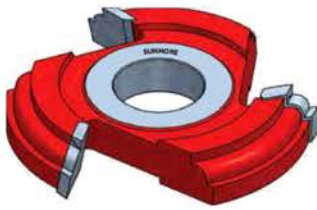

**Z=3**

● = Ready in stock   ■ = Delivery time 20 working days   △ = On request

D	S	F	BRAND
120	20	30	△ SUNMORE
120	25	30	△ SUNMORE
120	30	30	△ SUNMORE
120	35	30	△ SUNMORE
120	40	30	△ SUNMORE
120	50	30	△ SUNMORE
120	60	30	△ SUNMORE
120	70	30	△ SUNMORE
120	80	30	△ SUNMORE
120	90	30	△ SUNMORE
120	100	30	△ SUNMORE
160	20	30	△ SUNMORE
160	25	30	△ SUNMORE
160	30	30	△ SUNMORE
160	35	30	△ SUNMORE
160	40	30	△ SUNMORE
160	50	30	△ SUNMORE
160	60	30	△ SUNMORE
160	70	30	△ SUNMORE
160	80	30	△ SUNMORE
160	90	30	△ SUNMORE
160	100	30	△ SUNMORE
200	20	30	△ SUNMORE
200	25	30	△ SUNMORE
200	30	30	△ SUNMORE
200	35	30	△ SUNMORE
200	40	30	△ SUNMORE
200	50	30	△ SUNMORE
200	60	30	△ SUNMORE
200	70	30	△ SUNMORE
200	80	30	△ SUNMORE
200	90	30	△ SUNMORE
200	100	30	△ SUNMORE



MỘT SỐ HÌNH ẢNH VỀ TRIỂN LÃM QUỐC TẾ

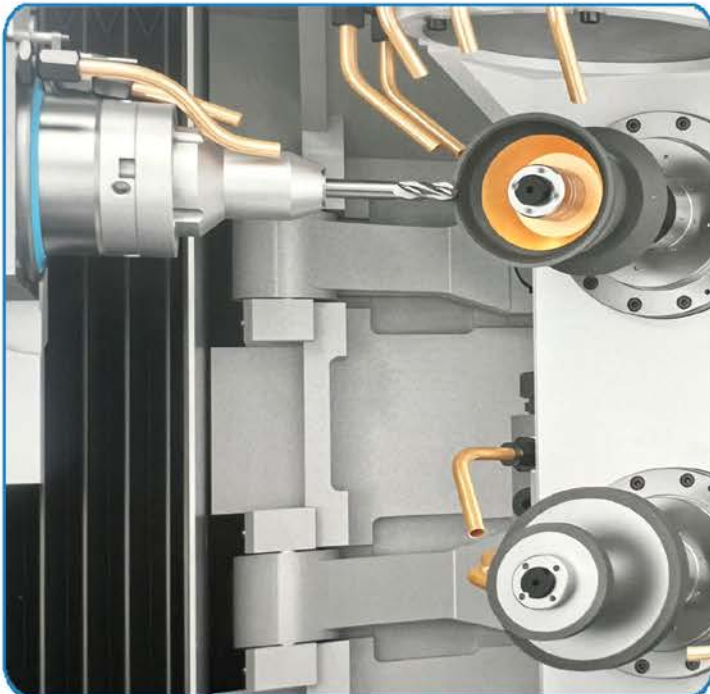



## MỘT SỐ HÌNH ẢNH VỀ TRIỂN LÃM QUỐC TẾ







## MỘT SỐ HÌNH ẢNH VỀ TRIỂN LÃM QUỐC TẾ





# Wood slitting blade

Application: Precise cutting

Machine: table saw.

Cutting: solid wood ripping

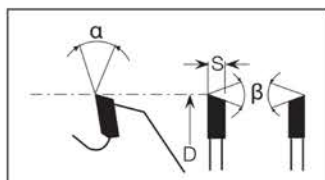

## II. LƯỚI CỬA RONG CẮT ĐA NĂNG

STT	Tên Hàng Hóa	Quy Cách				Thương Hiệu
		D	h/S	d	z	
5	Lưỡi cưa	150	2.2/3.2	25.4	30	SUNMORE
6	Lưỡi cưa	150	2.8/4.0	30	30	SUNMORE
7	Lưỡi cưa	150	3.2/5.0	40	30	SUNMORE
8	Lưỡi cưa	150	4.0/6.0	40	24	SUNMORE
9	Lưỡi cưa	180	1.2/1.6	60	24	SUNMORE
10	Lưỡi cưa	180	1.2/1.6	25.4	60	SUNMORE
11	Lưỡi cưa	180	1.4/2.2	25.4	60	SUNMORE
12	Lưỡi cưa	180	2.2/3.0	25.4	40	SUNMORE
13	Lưỡi cưa	180	2.8/4.0	25.4	40	SUNMORE
14	Lưỡi cưa	180	3.2/5.0	25.4	40	SUNMORE
15	Lưỡi cưa	180	4.0/6.0	25.4	40	SUNMORE
16	Lưỡi cưa	200	1.4/2.2	25.4	60	SUNMORE
17	Lưỡi cưa	200	1.6/2.4	25.4	40	SUNMORE
18	Lưỡi cưa	200	2.2/3.0	25.4	40	SUNMORE
19	Lưỡi cưa	200	2.2/3.0	25.4	60	SUNMORE
20	Lưỡi cưa	200	2.8/4.0	25.4	40	SUNMORE
21	Lưỡi cưa	200	3.2/5.0	25.4	40	SUNMORE



# Wood slitting blade

Application: Precise cutting

Machine: table saw.

Cutting: solid wood ripping

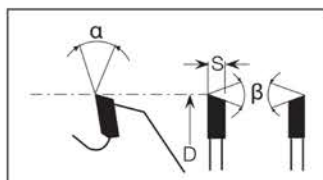

## II. LƯỠI CỬA RONG CẮT ĐA NĂNG

STT	Tên Hàng Hóa	Quy Cách				Thương Hiệu
		D	h/S	d	z	
22	Lưỡi cưa	240	0.9/1.3	65x3	36	SUNMORE
23	Lưỡi cưa	240	1.4/2.0	40/5	40	SUNMORE
24	Lưỡi cưa	240	1.2/1.6	40/5	40	SUNMORE
25	Lưỡi cưa	255	1.4/2.2	25.4	40	SUNMORE
26	Lưỡi cưa	255	1.6/2.4	25.4	40	SUNMORE
27	Lưỡi cưa	255	2.2/3.0	25.4	40	SUNMORE
28	Lưỡi cưa	255	2.2/3.0	25.4	60	SUNMORE
29	Lưỡi cưa	305	1.8/2.8	25.4	40	SUNMORE
30	Lưỡi cưa	305	1.6/2.2	25.4	36	SUNMORE
31	Lưỡi cưa	305	2.2/3.0	25.4	40	SUNMORE
32	Lưỡi cưa	305	2.2/3.0	25.4	48	SUNMORE
33	Lưỡi cưa	305	2.2/3.0	25.4	60	SUNMORE
34	Lưỡi cưa	300	2.2/3.2	25.4	72	SUNMORE



# Wood slitting blade

Application: Precise cutting

Machine: table saw.

Cutting: solid wood ripping

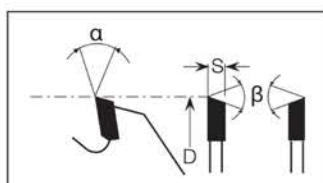

## II. LƯỖI CỬA RONG CẮT ĐA NĂNG

STT	Tên Hàng Hóa	Quy Cách				Thương Hiệu
		D	h/S	d	z	
35	Lưỡi cưa	350	2.4/3.2	25.4	40	SUNMORE
36	Lưỡi cưa	350	2.4/3.2	25.4	60	SUNMORE
37	Lưỡi cưa	400	2.5/3.5	25.4	40	SUNMORE
38	Lưỡi cưa	400	2.5/3.5	25.4	60	SUNMORE
39	Lưỡi cưa	455	3.4/4.5	25.4	40	SUNMORE
40	Lưỡi cưa	455	3.4/4.5	25.4	60	SUNMORE
41	Lưỡi cưa	505	3.4/4.5	25.4	40	SUNMORE
42	Lưỡi cưa	505	3.4/4.5	25.4	60	SUNMORE



## Solid wood cross cutting saw blade

Application: Precise cutting.

Machine: table saw, double end profiling machine

Cutting: solid wood latitude cutting, ply wood.

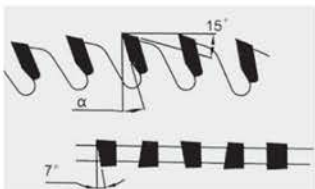

### I. LƯỠI CỬA CẮT TINH

STT	Tên Hàng Hóa	Quy Cách				Thương Hiệu
		D	h/S	d	z	
1	Lưỡi cưa	200	2.2/3.0	25.4	80	SUNMORE
2	Lưỡi cưa	255	2.2/3.0	25.4	80	SUNMORE
3	Lưỡi cưa	255	2.2/3.0	25.4	100	SUNMORE
4	Lưỡi cưa	255	2.2/3.0	25.4	120	SUNMORE
5	Lưỡi cưa	255	1.8/2.5	25.4	100	SUNMORE
6	Lưỡi cưa	255	0.9/1.1	25.4	80	SUNMORE
7	Lưỡi cưa	255	2.2/3.0	25.4	80	SUNMORE
8	Lưỡi cưa	255	2.8/4.0	25.4	100	SUNMORE
9	Lưỡi cưa	255	3.2/5.0	150	100	SUNMORE
10	Lưỡi cưa	305	2.8/4.0	25.4	80	SUNMORE
11	Lưỡi cưa	305	2.2/3.0	25.4	80	SUNMORE
12	Lưỡi cưa	305	2.2/3.0	25.4	100	SUNMORE
13	Lưỡi cưa	305	2.2/3.0	25.4	120	SUNMORE
14	Lưỡi cưa	305	2.8/4.0	25.4	100	SUNMORE
15	Lưỡi cưa	305	2.8/4.0	25.4	120	SUNMORE
16	Lưỡi cưa	305	3.2/5.0	25.4	100	SUNMORE
17	Lưỡi cưa	305	3.2/5.0	25.4	80	SUNMORE



## Solid wood cross cutting saw blade

Application: Precise cutting.

Machine: table saw, double end profiling machine

Cutting: solid wood latitude cutting, ply wood.



### L LƯỚI CỬA CẮT TINH

STT	Tên Hàng Hóa	Quy Cách				Thương Hiệu
		D	h/S	d	z	
18	Lưỡi cưa	355	2.4/3.2	25.4	100	SUNMORE
19	Lưỡi cưa	355	2.4/3.2	25.4	120	SUNMORE
20	Lưỡi cưa	355	2.2/3.0	25.4	100	SUNMORE
21	Lưỡi cưa	355	2.2/3.0	25.4	120	SUNMORE
22	Lưỡi cưa	355	2.8/4.0	25.4	80	SUNMORE
23	Lưỡi cưa	355	2.8/4.0	25.4	100	SUNMORE
24	Lưỡi cưa	355	2.8/4.0	25.4	120	SUNMORE
25	Lưỡi cưa	400	2.5/3.4	25.4	100	SUNMORE
26	Lưỡi cưa	405	2.5/3.4	25.4	120	SUNMORE
27	Lưỡi cưa	405	3.0/4.0	25.4	100	SUNMORE
28	Lưỡi cưa	405	3.0/4.0	25.4	120	SUNMORE
29	Lưỡi cưa	455	2.8/3.6	25.4	120	SUNMORE
30	Lưỡi cưa	455	2.6/3.4	25.4	120	SUNMORE
31	Lưỡi cưa	455	3.4/5.0	25.4	120	SUNMORE
32	Lưỡi cưa	455	3.0/4.0	25.4	120	SUNMORE
33	Lưỡi cưa	505	3.2/4.5	25.4	120	SUNMORE
34	Lưỡi cưa	610	3.4/4.5	25.4	120	SUNMORE
35	Lưỡi cưa	610	3.4/4.5	25.4	144	SUNMORE

# Conical scoring saw blade

Application: Pre-score

Machine: Pannel sizing machine, beam saw, table saw.

Cutting: double sided coating panel, MDF

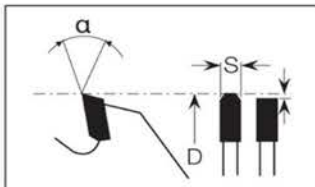

## III. LƯỖI CỬA MÁY BÀN TRƯỢT

STT	Tên Hàng Hóa	Quy Cách				Thương Hiệu
		D	h/S	d	z	
<b>Lưỡi trên</b>						
1	Lưỡi cưa	300	2.4/3.2	30	96	SUNMORE
2	Lưỡi cưa	300	2.4/3.2	30	72	SUNMORE
3	Lưỡi cưa	350	2.5/3.5	30	72	SUNMORE
4	Lưỡi cưa	350	2.5/3.5	30	108	SUNMORE
5	Lưỡi cưa	350	2.5/3.5	30	120	SUNMORE
6	Lưỡi cưa	350	2.5/3.5	30	100	SUNMORE
7	Lưỡi cưa	400	2.8/4.0	30	100	SUNMORE
8	Lưỡi cưa	400	2.8/4.0	30	120	SUNMORE
9	Lưỡi cưa	450	2.8/3.4	30	120	SUNMORE



# Conical scoring saw blade

Application: Pre-score

Machine: Pannel sizing machine, bean saw, table saw.

Cutting: double sided coating panel, MDF

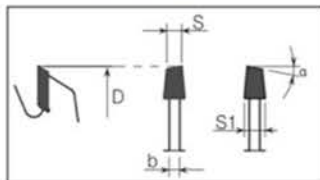

## III. LƯỚI CỬA MÁY BÀN TRƯỢT

STT	Tên Hàng Hóa	Quy Cách				Thương Hiệu
		D	h/S	d	z	
<b>Lưới dưới ( Lưới mỡi)</b>						
1	Lưới cửa	120	2.2	20	12+12	SUNMORE
2	Lưới cửa	120	3.1/4.3	20	24	SUNMORE



## Panel saw blade

Application: Precise cutting

Machine: table saw, beam saw,

Cutting: Panel material, coating material, MDF, solid wood.

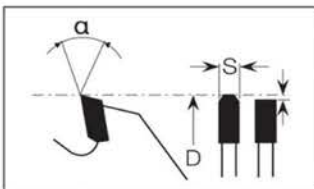

### IV. LƯỖI CỬA CHO MÁY PANEL SAW CNC CẮT VÁN CÔNG NGHIỆP

STT	Tên Hàng Hóa	Quy Cách				Thương Hiệu
		D	h/S	d	z	
<b>Lưỡi trên</b>						
1	Lưỡi cưa	300	3.2/4.4	65	60	SUNMORE
2	Lưỡi cưa	320	3.2/4.4	65	66	SUNMORE
3	Lưỡi cưa	350	3.2/4.4	65	72	SUNMORE
4	Lưỡi cưa	350	3.2/4.4	75	72	SUNMORE
5	Lưỡi cưa	350	3.2/4.4	80	72	SUNMORE
6	Lưỡi cưa	380	3.2/4.4	65	72	SUNMORE
7	Lưỡi cưa	380	3.2/4.4	75	72	SUNMORE
8	Lưỡi cưa	400	3.2/4.4	65	72	SUNMORE
9	Lưỡi cưa	400	3.2/4.4	75	72	SUNMORE
10	Lưỡi cưa	400	3.2/4.4	65	84	SUNMORE
11	Lưỡi cưa	400	3.2/4.4	75	84	SUNMORE
12	Lưỡi cưa	450	3.6/4.8	65	72	SUNMORE
13	Lưỡi cưa	450	3.6/4.8	65	84	SUNMORE



## Panel saw blade

Application: Precise cutting

Machine: table saw, beam saw,

Cutting: Panel material, coating material, MDF, solid wood.

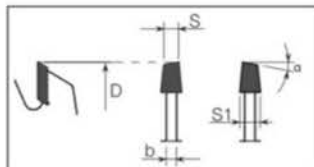

### IV. LƯỠI CỬA MÔI CHO MÁY PANEL SAW CNC CẮT VÁN CÔNG NGHIỆP

STT	Tên Hàng Hóa	Quy Cách				Thương Hiệu
		D	h/S	d	z	
<b>Lưỡi dưới</b>						
1	Lưỡi cưa	160	4.3/5.8	45	36	SUNMORE
2	Lưỡi cưa	180	4.3/5.8	45	36	SUNMORE
3	Lưỡi cưa	200	4.3/5.8	45	36	SUNMORE
4	Lưỡi cưa	180	4.8/6.3	45	36	SUNMORE



# Multi-ripping saw blade with rakers

Application: Precise cutting

Machine: circular/square multi-rip saw, table saw.

Cutting: Most for wet wood with humidity > 15% like cypress or other hard wood.

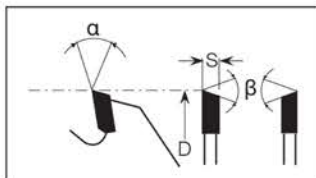

## V. LƯỚI CỬA RONG XẼ GỖ TƯỚI

STT	Tên Hàng Hóa	Quy Cách				Thương Hiệu
		D	h/S	d	z	
1	Lưỡi cưa	180	1.6/2.4	45	24+2z	SUNMORE
2	Lưỡi cưa	180	2.2/3.0	45	24+2z	SUNMORE
3	Lưỡi cưa	180	2.8/4.0	45	24+2z	SUNMORE
4	Lưỡi cưa	230	2.2/3.0	45	24+3z	SUNMORE
5	Lưỡi cưa	230	2.8/4.0	45	24+3z	SUNMORE
6	Lưỡi cưa	255	1.8/2.4	45	24+3z	SUNMORE
7	Lưỡi cưa	255	2.2/3.0	45	24+3z	SUNMORE
8	Lưỡi cưa	255	2.8/4.0	45	24+3z	SUNMORE
9	Lưỡi cưa	280	2.2/3.0	45	24+3z	SUNMORE
10	Lưỡi cưa	280	2.8/4.0	45	24+3z	SUNMORE
11	Lưỡi cưa	305	1.8/2.4	45	28+4z	SUNMORE
12	Lưỡi cưa	305	2.2/3.0	45	28+4z	SUNMORE
13	Lưỡi cưa	305	2.8/4.0	45	28+4z	SUNMORE
14	Lưỡi cưa	355	2.4/3.2	55	36+4z	SUNMORE
15	Lưỡi cưa	355	2.8/3.5	55	36+4z	SUNMORE
16	Lưỡi cưa	355	3.2/4.0	55	36+4z	SUNMORE
17	Lưỡi cưa	380	2.8/3.5	55	36+4z	SUNMORE
18	Lưỡi cưa	405	2.8/3.5	55	36+4z	SUNMORE
19	Lưỡi cưa	405	3.2/4.0	55	36+4z	SUNMORE
20	Lưỡi cưa	455	3.2/4.0	60	36+6z	SUNMORE
21	Lưỡi cưa	455	3.2/4.4	60	36+6z	SUNMORE
22	Lưỡi cưa	650	3.6/4.6	40	48+6z	SUNMORE



# Wood slitting blade

Application: Precise cutting

Machine: table saw.

Cutting: solid wood ripping

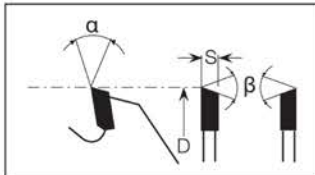

## VI. LƯỚI CỬA CẮT RÀNH

STT	Tên Hàng Hóa	Quy Cách				Thương Hiệu
		D	h/S	d	z	
1	Lưỡi cưa	180	4.0	25.4	40	SUNMORE
2	Lưỡi cưa	180	5.0	25.4	40	SUNMORE
3	Lưỡi cưa	180	6.0	25.4	40	SUNMORE
4	Lưỡi cưa	180	8.0	25.4	30	SUNMORE
5	Lưỡi cưa	180	9.0	25.4	30	SUNMORE
6	Lưỡi cưa	180	10.0	25.4	24	SUNMORE
7	Lưỡi cưa	200	4.0	25.4	60	SUNMORE
8	Lưỡi cưa	200	5.0	25.4	60	SUNMORE
9	Lưỡi cưa	200	6.0	25.4	60	SUNMORE
10	Lưỡi cưa	200	8.0	25.4	40	SUNMORE
11	Lưỡi cưa	200	10.0	25.4	30	SUNMORE



# Cutting aluminum

Application: Latitude cutting, ends cutting

Machine: Panel saw, double miter saw, V-shape cutting machine.

Cutting: Aluminum, reinforced plastic, non-ferrous metal, etc.

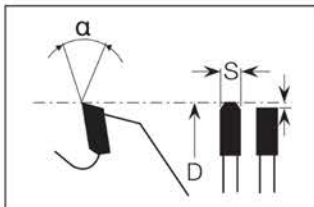

## VII. LƯỚI CỬA NHÔM/ NHỰA/ MECA

STT	Tên Hàng Hóa	Quy Cách				Thương Hiệu
		D	h/S	d	z	
1	Lưỡi cưa	255	2.0/2.8	25.4	100	SUNMORE
2	Lưỡi cưa	255	2.0/2.8	25.4	120	SUNMORE
3	Lưỡi cưa	305	2.4/3.0	25.4	60	SUNMORE
4	Lưỡi cưa	305	2.4/3.0	25.4	120	SUNMORE
5	Lưỡi cưa	355	2.4/3.0	25.4	120	SUNMORE
6	Lưỡi cưa	405	2.4/3.0	25.4	120	SUNMORE
7	Lưỡi cưa	405	2.6/3.2	25.4	120	SUNMORE
8	Lưỡi cưa	455	2.6/3.2	25.4	120	SUNMORE
9	Lưỡi cưa	450	3.2/4.0	25.4	144	SUNMORE
10	Lưỡi cưa	510	3.2/4.0	25.4	120	SUNMORE
11	Lưỡi cưa	510	3.2/4.0	25.4	144	SUNMORE
12	Lưỡi cưa	610	3.4/4.2	30	120	SUNMORE
13	Lưỡi cưa	610	3.4/4.2	30	144	SUNMORE
14	Lưỡi cưa	610	3.4/4.2	30	60	SUNMORE
15	Lưỡi cưa	700	6.0/7.0	30	120	SUNMORE
16	Lưỡi cưa	800	6.0/7.0	50	120	SUNMORE
17	Lưỡi cưa	750	6.0/7.0	50	60	SUNMORE
18	Lưỡi cưa	800	6.0/7.0	50	80	SUNMORE

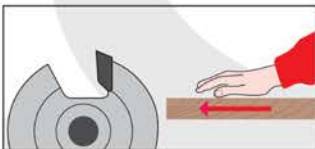
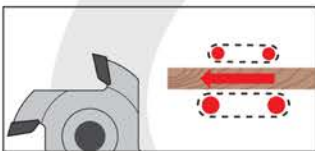
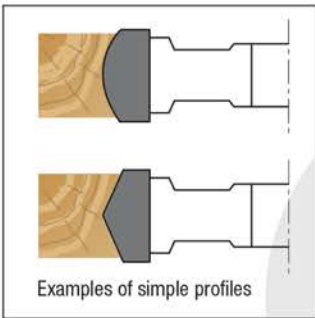
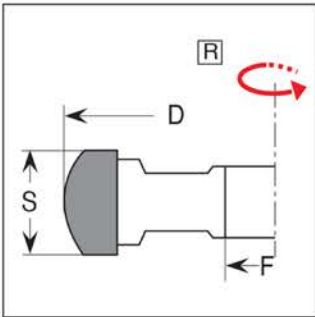
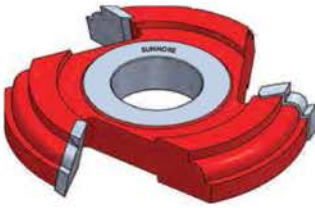

Z=3

● = Ready in stock   ■ = Delivery time 20 working days   △ = On request

D	S	F	BRAND
120	20	30	△ SUNMORE
120	25	30	△ SUNMORE
120	30	30	△ SUNMORE
120	35	30	△ SUNMORE
120	40	30	△ SUNMORE
120	50	30	△ SUNMORE
120	60	30	△ SUNMORE
120	70	30	△ SUNMORE
120	80	30	△ SUNMORE
120	90	30	△ SUNMORE
120	100	30	△ SUNMORE
160	20	30	△ SUNMORE
160	25	30	△ SUNMORE
160	30	30	△ SUNMORE
160	35	30	△ SUNMORE
160	40	30	△ SUNMORE
160	50	30	△ SUNMORE
160	60	30	△ SUNMORE
160	70	30	△ SUNMORE
160	80	30	△ SUNMORE
160	90	30	△ SUNMORE
160	100	30	△ SUNMORE
200	20	30	△ SUNMORE
200	25	30	△ SUNMORE
200	30	30	△ SUNMORE
200	35	30	△ SUNMORE
200	40	30	△ SUNMORE
200	50	30	△ SUNMORE
200	60	30	△ SUNMORE
200	70	30	△ SUNMORE
200	80	30	△ SUNMORE
200	90	30	△ SUNMORE
200	100	30	△ SUNMORE

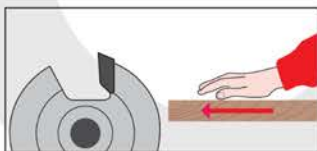
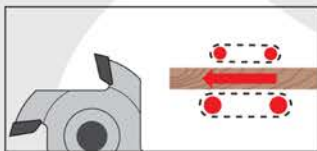
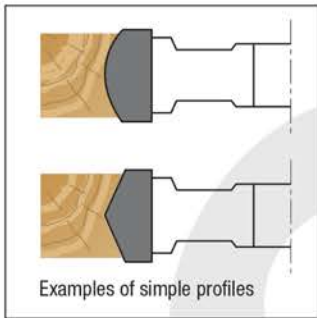
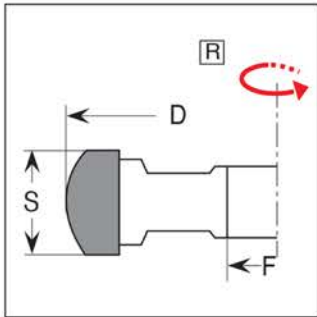

Z=4

● = Ready in stock   ■ = Delivery time 20 working days   △ = On request

D	S	F	BRAND
120	20	30	△ SUNMORE
120	25	30	△ SUNMORE
120	30	30	△ SUNMORE
120	35	30	△ SUNMORE
120	40	30	△ SUNMORE
120	50	30	△ SUNMORE
120	60	30	△ SUNMORE
120	70	30	△ SUNMORE
120	80	30	△ SUNMORE
120	90	30	△ SUNMORE
120	100	30	△ SUNMORE
160	20	30	△ SUNMORE
160	25	30	△ SUNMORE
160	30	30	△ SUNMORE
160	35	30	△ SUNMORE
160	40	30	△ SUNMORE
160	50	30	△ SUNMORE
160	60	30	△ SUNMORE
160	70	30	△ SUNMORE
160	80	30	△ SUNMORE
160	90	30	△ SUNMORE
160	100	30	△ SUNMORE
200	20	30	△ SUNMORE
200	25	30	△ SUNMORE
200	30	30	△ SUNMORE
200	35	30	△ SUNMORE
200	40	30	△ SUNMORE
200	50	30	△ SUNMORE
200	60	30	△ SUNMORE
200	70	30	△ SUNMORE
200	80	30	△ SUNMORE
200	90	30	△ SUNMORE
200	100	30	△ SUNMORE

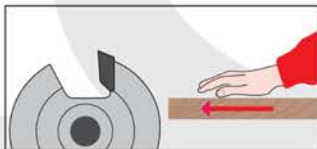
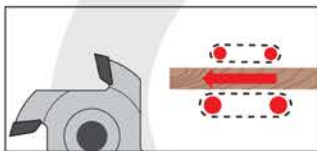
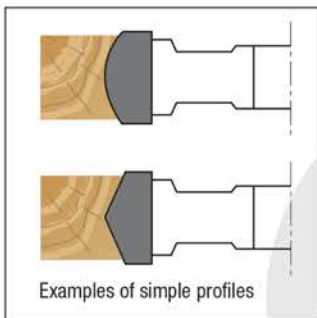
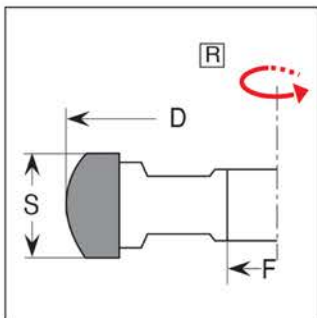
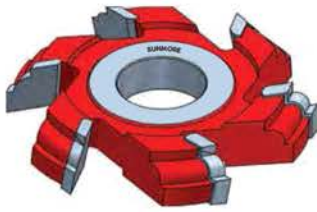

**Z=6**

● = Ready in stock   ■ = Delivery time 20 working days   △ = On request

D	S	F	BRAND
120	20	30	△ SUNMORE
120	25	30	△ SUNMORE
120	30	30	△ SUNMORE
120	35	30	△ SUNMORE
120	40	30	△ SUNMORE
120	50	30	△ SUNMORE
120	60	30	△ SUNMORE
120	70	30	△ SUNMORE
120	80	30	△ SUNMORE
120	90	30	△ SUNMORE
120	100	30	△ SUNMORE
160	20	30	△ SUNMORE
160	25	30	△ SUNMORE
160	30	30	△ SUNMORE
160	35	30	△ SUNMORE
160	40	30	△ SUNMORE
160	50	30	△ SUNMORE
160	60	30	△ SUNMORE
160	70	30	△ SUNMORE
160	80	30	△ SUNMORE
160	90	30	△ SUNMORE
160	100	30	△ SUNMORE
200	20	30	△ SUNMORE
200	25	30	△ SUNMORE
200	30	30	△ SUNMORE
200	35	30	△ SUNMORE
200	40	30	△ SUNMORE
200	50	30	△ SUNMORE
200	60	30	△ SUNMORE
200	70	30	△ SUNMORE
200	80	30	△ SUNMORE
200	90	30	△ SUNMORE
200	100	30	△ SUNMORE



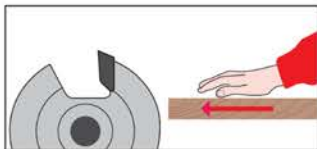
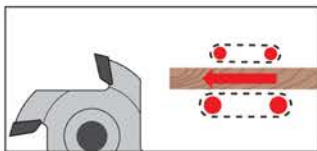
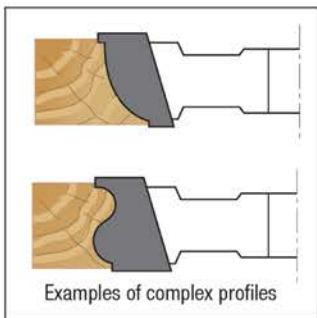
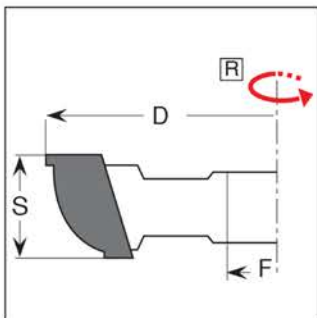
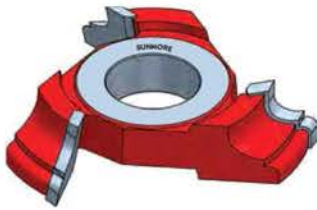

**Z=3**

● = Ready in stock   ■ = Delivery time 20 working days   △ = On request

D	S	F	BRAND
120	20	30	△ SUNMORE
120	25	30	△ SUNMORE
120	30	30	△ SUNMORE
120	35	30	△ SUNMORE
120	40	30	△ SUNMORE
120	50	30	△ SUNMORE
120	60	30	△ SUNMORE
120	70	30	△ SUNMORE
120	80	30	△ SUNMORE
120	90	30	△ SUNMORE
120	100	30	△ SUNMORE
160	20	30	△ SUNMORE
160	25	30	△ SUNMORE
160	30	30	△ SUNMORE
160	35	30	△ SUNMORE
160	40	30	△ SUNMORE
160	50	30	△ SUNMORE
160	60	30	△ SUNMORE
160	70	30	△ SUNMORE
160	80	30	△ SUNMORE
160	90	30	△ SUNMORE
160	100	30	△ SUNMORE
200	20	30	△ SUNMORE
200	25	30	△ SUNMORE
200	30	30	△ SUNMORE
200	35	30	△ SUNMORE
200	40	30	△ SUNMORE
200	50	30	△ SUNMORE
200	60	30	△ SUNMORE
200	70	30	△ SUNMORE
200	80	30	△ SUNMORE
200	90	30	△ SUNMORE
200	100	30	△ SUNMORE

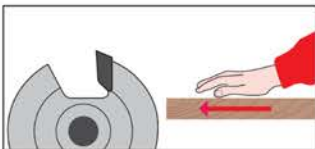
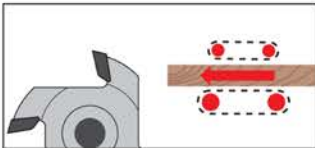
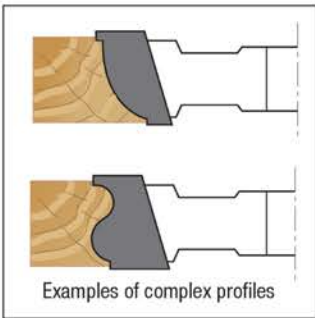
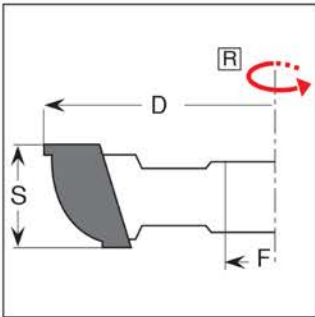

Z=4

● = Ready in stock   ■ = Delivery time 20 working days   △ = On request

D	S	F	BRAND
120	20	30	△ SUNMORE
120	25	30	△ SUNMORE
120	30	30	△ SUNMORE
120	35	30	△ SUNMORE
120	40	30	△ SUNMORE
120	50	30	△ SUNMORE
120	60	30	△ SUNMORE
120	70	30	△ SUNMORE
120	80	30	△ SUNMORE
120	90	30	△ SUNMORE
120	100	30	△ SUNMORE
160	20	30	△ SUNMORE
160	25	30	△ SUNMORE
160	30	30	△ SUNMORE
160	35	30	△ SUNMORE
160	40	30	△ SUNMORE
160	50	30	△ SUNMORE
160	60	30	△ SUNMORE
160	70	30	△ SUNMORE
160	80	30	△ SUNMORE
160	90	30	△ SUNMORE
160	100	30	△ SUNMORE
200	20	30	△ SUNMORE
200	25	30	△ SUNMORE
200	30	30	△ SUNMORE
200	35	30	△ SUNMORE
200	40	30	△ SUNMORE
200	50	30	△ SUNMORE
200	60	30	△ SUNMORE
200	70	30	△ SUNMORE
200	80	30	△ SUNMORE
200	90	30	△ SUNMORE
200	100	30	△ SUNMORE

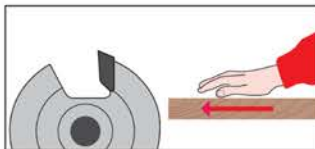
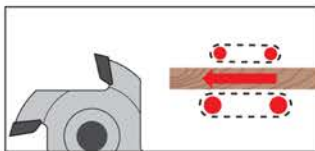
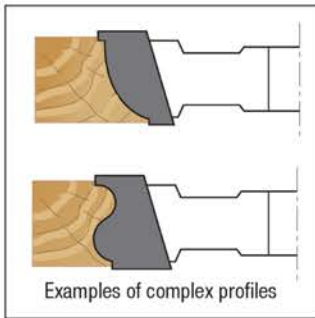
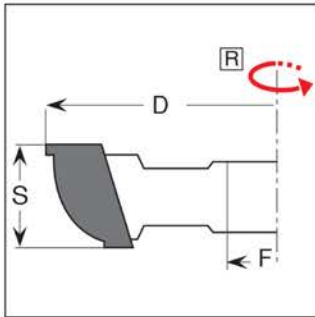

**Z=6**

● = Ready in stock   ■ = Delivery time 20 working days   △ = On request

D	S	F	BRAND
120	20	30	△ SUNMORE
120	25	30	△ SUNMORE
120	30	30	△ SUNMORE
120	35	30	△ SUNMORE
120	40	30	△ SUNMORE
120	50	30	△ SUNMORE
120	60	30	△ SUNMORE
120	70	30	△ SUNMORE
120	80	30	△ SUNMORE
120	90	30	△ SUNMORE
120	100	30	△ SUNMORE
160	20	30	△ SUNMORE
160	25	30	△ SUNMORE
160	30	30	△ SUNMORE
160	35	30	△ SUNMORE
160	40	30	△ SUNMORE
160	50	30	△ SUNMORE
160	60	30	△ SUNMORE
160	70	30	△ SUNMORE
160	80	30	△ SUNMORE
160	90	30	△ SUNMORE
160	100	30	△ SUNMORE
200	20	30	△ SUNMORE
200	25	30	△ SUNMORE
200	30	30	△ SUNMORE
200	35	30	△ SUNMORE
200	40	30	△ SUNMORE
200	50	30	△ SUNMORE
200	60	30	△ SUNMORE
200	70	30	△ SUNMORE
200	80	30	△ SUNMORE
200	90	30	△ SUNMORE
200	100	30	△ SUNMORE

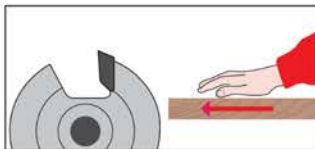
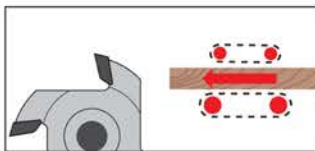
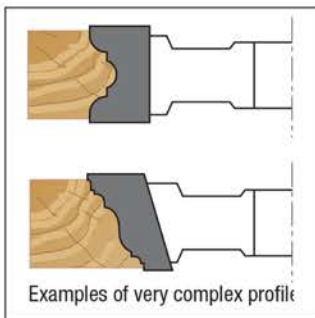
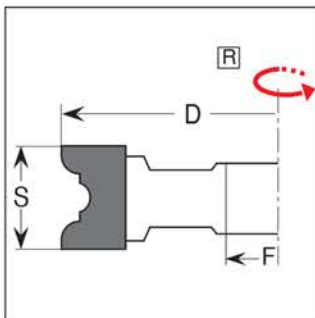

**Z=3**

● = Ready in stock   ■ = Delivery time 20 working days   △ = On request

D	S	F	BRAND
120	20	30	△ SUNMORE
120	25	30	△ SUNMORE
120	30	30	△ SUNMORE
120	35	30	△ SUNMORE
120	40	30	△ SUNMORE
120	50	30	△ SUNMORE
120	60	30	△ SUNMORE
120	70	30	△ SUNMORE
120	80	30	△ SUNMORE
120	90	30	△ SUNMORE
120	100	30	△ SUNMORE
160	20	30	△ SUNMORE
160	25	30	△ SUNMORE
160	30	30	△ SUNMORE
160	35	30	△ SUNMORE
160	40	30	△ SUNMORE
160	50	30	△ SUNMORE
160	60	30	△ SUNMORE
160	70	30	△ SUNMORE
160	80	30	△ SUNMORE
160	90	30	△ SUNMORE
160	100	30	△ SUNMORE
200	20	30	△ SUNMORE
200	25	30	△ SUNMORE
200	30	30	△ SUNMORE
200	35	30	△ SUNMORE
200	40	30	△ SUNMORE
200	50	30	△ SUNMORE
200	60	30	△ SUNMORE
200	70	30	△ SUNMORE
200	80	30	△ SUNMORE
200	90	30	△ SUNMORE
200	100	30	△ SUNMORE

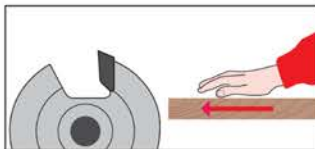
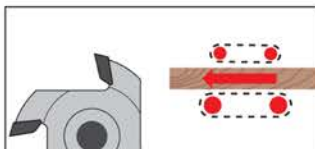
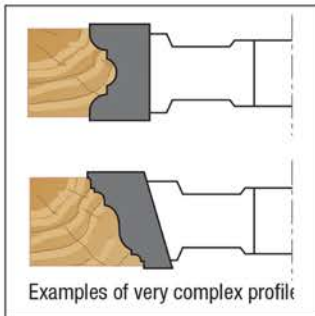
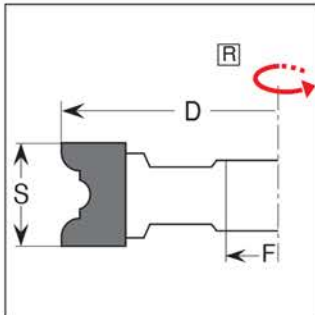

Z=4

● = Ready in stock   ■ = Delivery time 20 working days   △ = On request

D	S	F	BRAND
120	20	30	△ SUNMORE
120	25	30	△ SUNMORE
120	30	30	△ SUNMORE
120	35	30	△ SUNMORE
120	40	30	△ SUNMORE
120	50	30	△ SUNMORE
120	60	30	△ SUNMORE
120	70	30	△ SUNMORE
120	80	30	△ SUNMORE
120	90	30	△ SUNMORE
120	100	30	△ SUNMORE
160	20	30	△ SUNMORE
160	25	30	△ SUNMORE
160	30	30	△ SUNMORE
160	35	30	△ SUNMORE
160	40	30	△ SUNMORE
160	50	30	△ SUNMORE
160	60	30	△ SUNMORE
160	70	30	△ SUNMORE
160	80	30	△ SUNMORE
160	90	30	△ SUNMORE
160	100	30	△ SUNMORE
200	20	30	△ SUNMORE
200	25	30	△ SUNMORE
200	30	30	△ SUNMORE
200	35	30	△ SUNMORE
200	40	30	△ SUNMORE
200	50	30	△ SUNMORE
200	60	30	△ SUNMORE
200	70	30	△ SUNMORE
200	80	30	△ SUNMORE
200	90	30	△ SUNMORE
200	100	30	△ SUNMORE

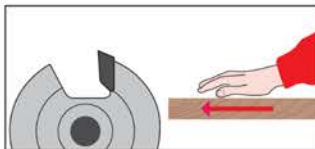
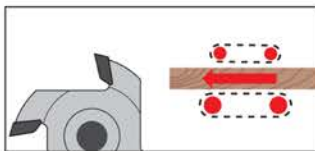
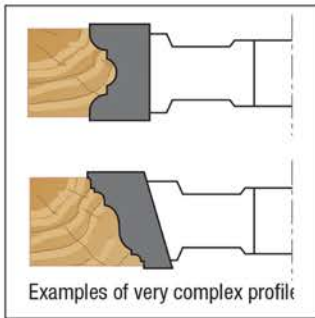
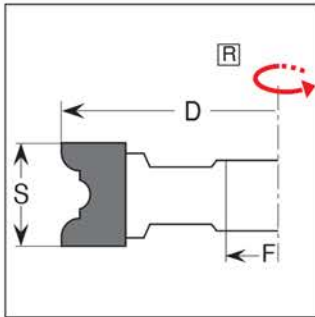
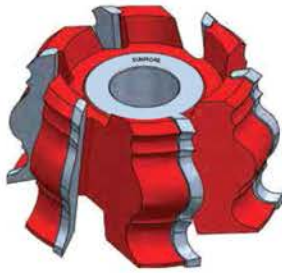

**Z=6**

● = Ready in stock   ■ = Delivery time 20 working days   △ = On request

D	S	F	BRAND
120	20	30	△ SUNMORE
120	25	30	△ SUNMORE
120	30	30	△ SUNMORE
120	35	30	△ SUNMORE
120	40	30	△ SUNMORE
120	50	30	△ SUNMORE
120	60	30	△ SUNMORE
120	70	30	△ SUNMORE
120	80	30	△ SUNMORE
120	90	30	△ SUNMORE
120	100	30	△ SUNMORE
160	20	30	△ SUNMORE
160	25	30	△ SUNMORE
160	30	30	△ SUNMORE
160	35	30	△ SUNMORE
160	40	30	△ SUNMORE
160	50	30	△ SUNMORE
160	60	30	△ SUNMORE
160	70	30	△ SUNMORE
160	80	30	△ SUNMORE
160	90	30	△ SUNMORE
160	100	30	△ SUNMORE
200	20	30	△ SUNMORE
200	25	30	△ SUNMORE
200	30	30	△ SUNMORE
200	35	30	△ SUNMORE
200	40	30	△ SUNMORE
200	50	30	△ SUNMORE
200	60	30	△ SUNMORE
200	70	30	△ SUNMORE
200	80	30	△ SUNMORE
200	90	30	△ SUNMORE
200	100	30	△ SUNMORE

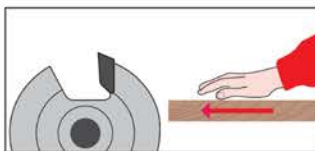
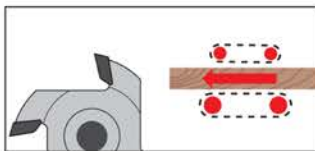
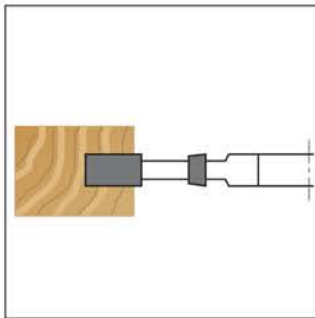
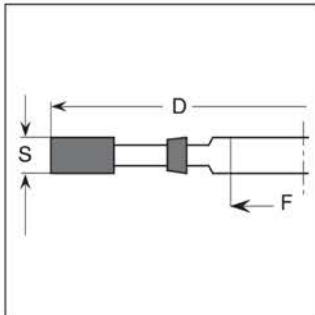
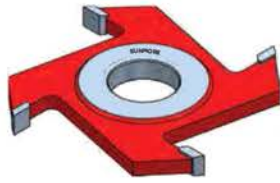

Z=4

● = Ready in stock    ■ = Delivery time 20 working days    △ = On request

D	S	F	BRAND
120	4	30	■ SUNMORE
120	6	30	■ SUNMORE
120	8	30	■ SUNMORE
120	10	30	■ SUNMORE
120	12	30	■ SUNMORE
120	14	30	■ SUNMORE
140	4	30	■ SUNMORE
140	6	30	■ SUNMORE
140	8	30	■ SUNMORE
140	10	30	■ SUNMORE
140	12	30	■ SUNMORE
140	14	30	■ SUNMORE
160	4	30	■ SUNMORE
160	6	30	■ SUNMORE
160	8	30	■ SUNMORE
160	10	30	■ SUNMORE
160	12	30	■ SUNMORE
160	14	30	■ SUNMORE

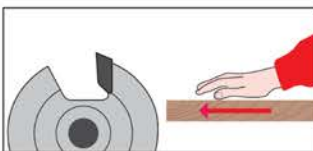
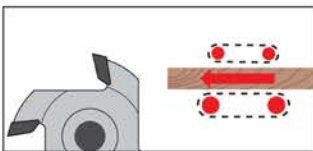
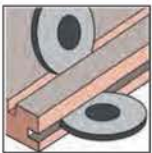
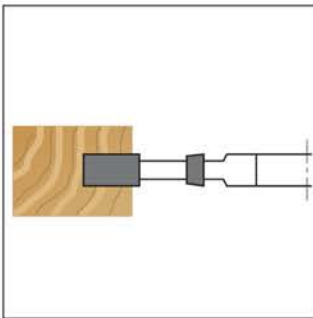
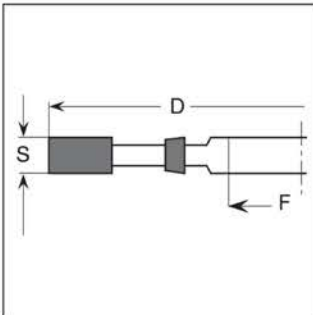
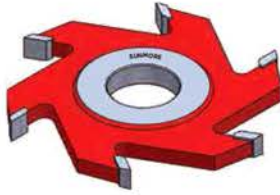

Z=6

● = Ready in stock   ■ = Delivery time 20 working days   △ = On request

D	S	F	BRAND
120	4	30	■ SUNMORE
120	6	30	■ SUNMORE
120	8	30	■ SUNMORE
120	10	30	■ SUNMORE
120	12	30	■ SUNMORE
120	14	30	■ SUNMORE
140	4	30	■ SUNMORE
140	6	30	■ SUNMORE
140	8	30	■ SUNMORE
140	10	30	■ SUNMORE
140	12	30	■ SUNMORE
140	14	30	■ SUNMORE
160	4	30	■ SUNMORE
160	6	30	■ SUNMORE
160	8	30	■ SUNMORE
160	10	30	■ SUNMORE
160	12	30	■ SUNMORE
160	14	30	■ SUNMORE



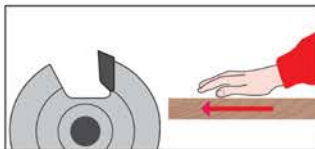
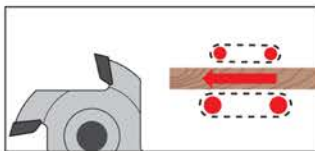
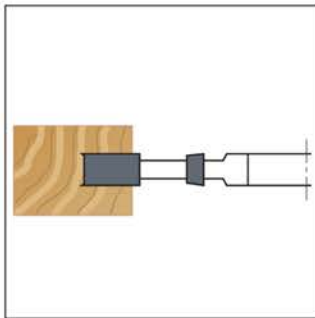
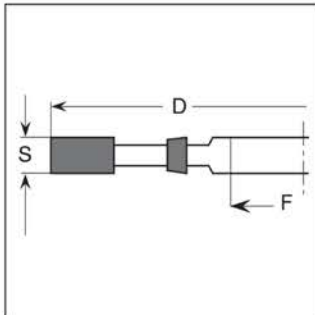
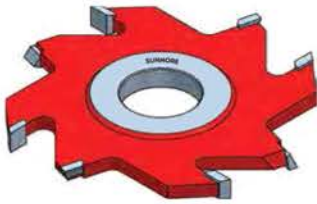

**Z=4+4**

● = Ready in stock   ■ = Delivery time 20 working days   △ = On request

D	S	F	BRAND
120	4	30	■ SUNMORE
120	5	30	■ SUNMORE
120	6	30	■ SUNMORE
120	8	30	■ SUNMORE
120	10	30	■ SUNMORE
120	12	30	■ SUNMORE
120	14	30	■ SUNMORE
140	4	30	■ SUNMORE
140	5	30	■ SUNMORE
140	6	30	■ SUNMORE
140	8	30	■ SUNMORE
140	10	30	■ SUNMORE
140	12	30	■ SUNMORE
140	14	30	■ SUNMORE
160	4	30	■ SUNMORE
160	5	30	■ SUNMORE
160	6	30	■ SUNMORE
160	8	30	■ SUNMORE
160	10	30	■ SUNMORE
160	12	30	■ SUNMORE
160	14	30	■ SUNMORE
200	4	40	■ SUNMORE
200	5	40	■ SUNMORE
200	6	40	■ SUNMORE
200	8	40	■ SUNMORE
200	10	40	■ SUNMORE
200	12	40	■ SUNMORE
200	14	40	■ SUNMORE

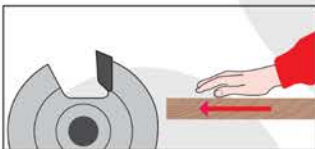
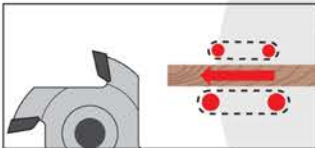
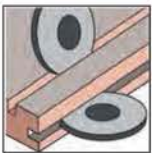
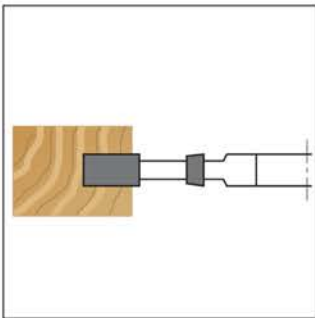
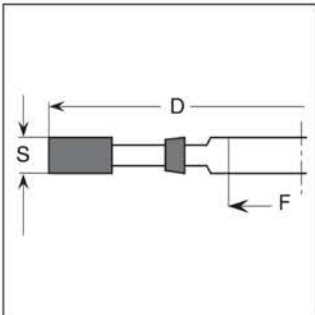
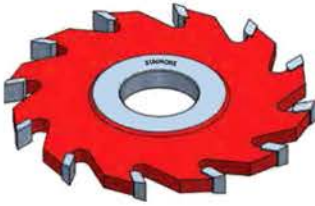

Z=12

● = Ready in stock   ■ = Delivery time 20 working days   △ = On request

D	S	F	BRAND
140	4	30	■ SUNMORE
140	6	30	■ SUNMORE
140	8	30	■ SUNMORE
140	10	30	■ SUNMORE
140	12	30	■ SUNMORE
140	14	30	■ SUNMORE
160	4	30	■ SUNMORE
160	6	30	■ SUNMORE
160	8	30	■ SUNMORE
160	10	30	■ SUNMORE
160	12	30	■ SUNMORE
160	14	30	■ SUNMORE
200	4	40	■ SUNMORE
200	6	40	■ SUNMORE
200	8	40	■ SUNMORE
200	10	40	■ SUNMORE
200	12	40	■ SUNMORE
200	14	40	■ SUNMORE

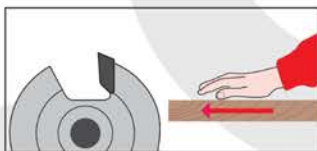
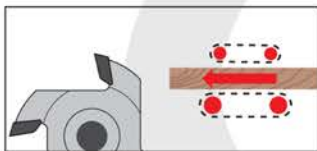
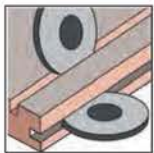
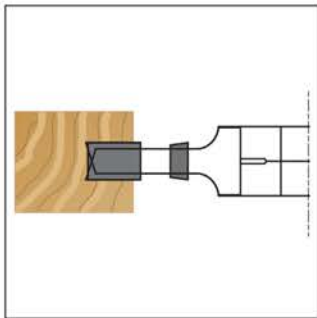
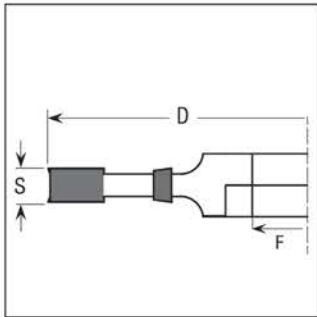

Z=4 V=4

● = Ready in stock   ■ = Delivery time 20 working days   △ = On request

D	S	F	BRAND
150	4÷7,5	30	■ SUNMORE
150	7,5÷14,5	30	■ SUNMORE
150	10÷19	30	■ SUNMORE
			SUNMORE

SPACING COLLARS SET

S	BRAND
4÷7,5	△ SUNMORE
7,5÷14,5	△ SUNMORE
10÷19	△ SUNMORE

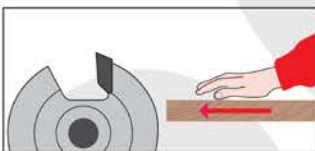
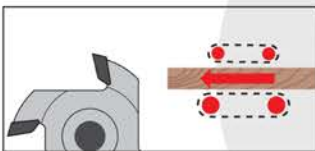
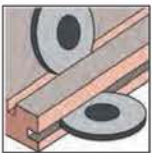
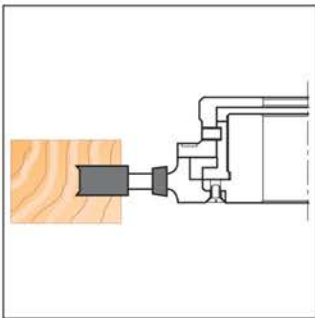
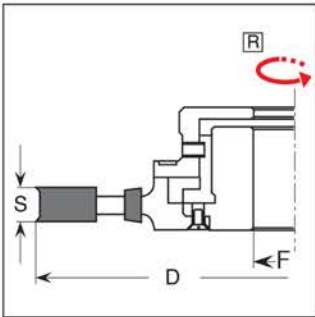

**Z=4 V=4**

● = Ready in stock   ■ = Delivery time 20 working days   △ = On request

D	S	F	BRAND
150	4÷7,5	30	■ SUNMORE
150	7,5÷14,5	30	■ SUNMORE
150	10÷19	30	■ SUNMORE

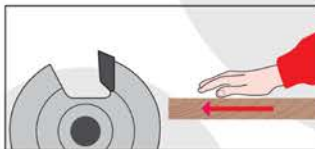
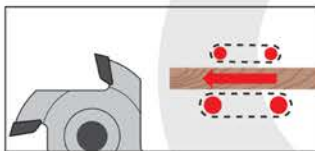
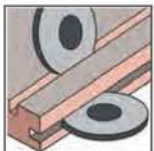
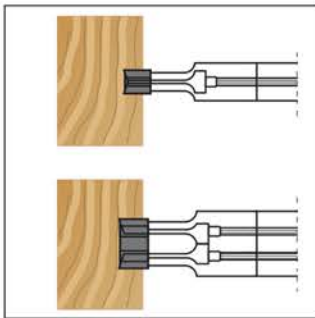
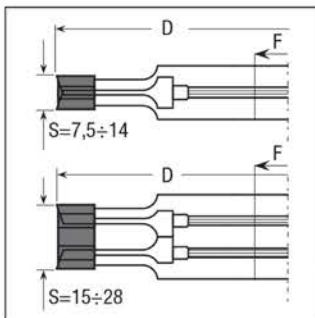
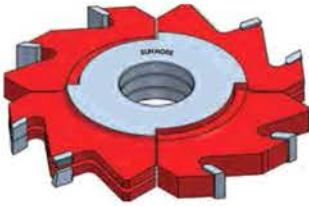

Z=4+4 V=4

● = Ready in stock

■ = Delivery time 20 working days

△ = On request

D	S	F	BRAND
150	7,5÷28	30	■ SUNMORE

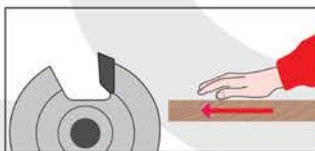
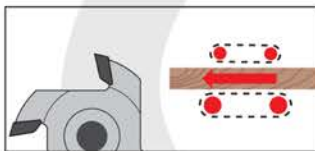
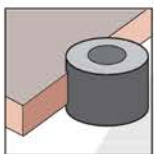
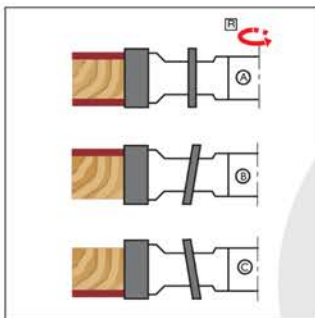
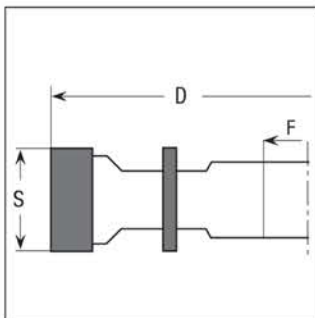
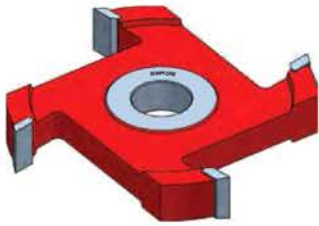

Z=4

● = Ready in stock   ■ = Delivery time 20 working days   △ = On request

D	S	F	BRAND
120	20	30	■ SUNMORE
120	25	30	■ SUNMORE
120	30	30	■ SUNMORE
120	35	30	■ SUNMORE
120	40	30	■ SUNMORE
120	50	30	■ SUNMORE
120	60	30	■ SUNMORE
120	70	30	■ SUNMORE
120	80	30	■ SUNMORE
160	20	30	■ SUNMORE
160	25	30	■ SUNMORE
160	30	30	■ SUNMORE
160	35	30	■ SUNMORE
160	40	30	■ SUNMORE
160	50	30	■ SUNMORE
160	60	30	■ SUNMORE
160	70	30	■ SUNMORE
160	80	30	■ SUNMORE
200	20	40	■ SUNMORE
200	25	40	■ SUNMORE
200	30	40	■ SUNMORE
200	35	40	■ SUNMORE
200	40	40	■ SUNMORE
200	50	40	■ SUNMORE
200	60	40	■ SUNMORE
200	70	40	■ SUNMORE
200	80	40	■ SUNMORE

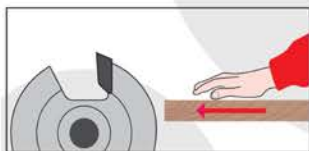
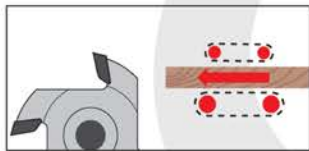
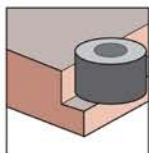
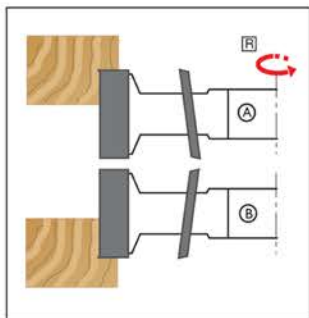
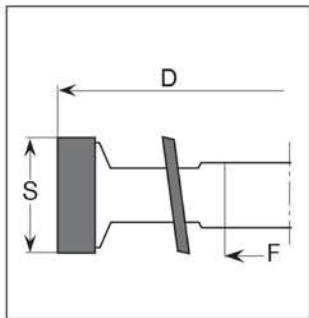
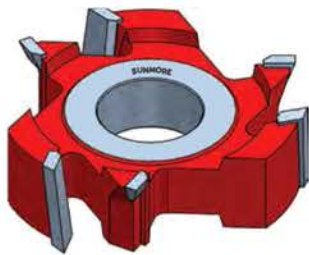

Z=3 V=3

● = Ready in stock ■ = Delivery time 20 working days △ = On request

D	S	F	BRAND
120	15	30	■ SUNMORE
120	20	30	■ SUNMORE
120	25	30	■ SUNMORE
120	30	30	■ SUNMORE
120	35	30	■ SUNMORE
120	40	30	■ SUNMORE
120	50	30	■ SUNMORE
120	60	30	■ SUNMORE
120	70	30	■ SUNMORE
120	80	30	■ SUNMORE
160	15	30	■ SUNMORE
160	20	30	■ SUNMORE
160	25	30	■ SUNMORE
160	30	30	■ SUNMORE
160	35	30	■ SUNMORE
160	40	30	■ SUNMORE
160	50	30	■ SUNMORE
160	60	30	■ SUNMORE
160	70	30	■ SUNMORE
160	80	30	■ SUNMORE
200	15	40	■ SUNMORE
200	20	40	■ SUNMORE
200	25	40	■ SUNMORE
200	30	40	■ SUNMORE
200	35	40	■ SUNMORE
200	40	40	■ SUNMORE
200	50	40	■ SUNMORE
200	60	40	■ SUNMORE
200	70	40	■ SUNMORE
200	80	40	■ SUNMORE

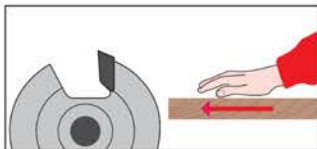
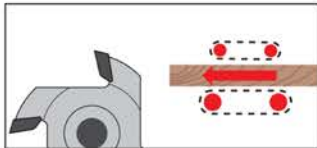
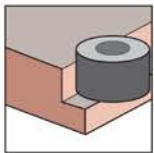
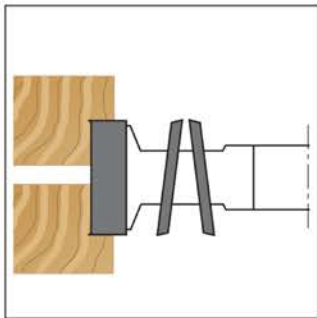
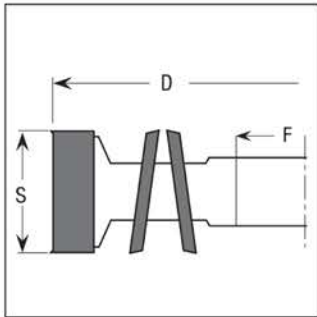
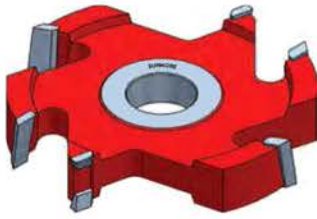

Z=4 V=4

● = Ready in stock ■ = Delivery time 20 working days △ = On request

D	S	F	BRAND
120	20	30	■ SUNMORE
120	25	30	■ SUNMORE
120	30	30	■ SUNMORE
120	35	30	■ SUNMORE
120	40	30	■ SUNMORE
120	50	30	■ SUNMORE
120	60	30	■ SUNMORE
120	70	30	■ SUNMORE
120	80	30	■ SUNMORE
160	20	30	■ SUNMORE
160	25	30	■ SUNMORE
160	30	30	■ SUNMORE
160	35	30	■ SUNMORE
160	40	30	■ SUNMORE
160	50	30	■ SUNMORE
160	60	30	■ SUNMORE
160	70	30	■ SUNMORE
160	80	30	■ SUNMORE
200	20	40	■ SUNMORE
200	25	40	■ SUNMORE
200	30	40	■ SUNMORE
200	35	40	■ SUNMORE
200	40	40	■ SUNMORE
200	50	40	■ SUNMORE
200	60	40	■ SUNMORE
200	70	40	■ SUNMORE
200	80	40	■ SUNMORE



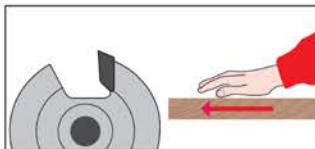
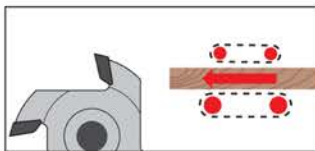
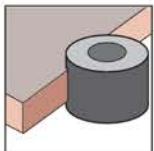
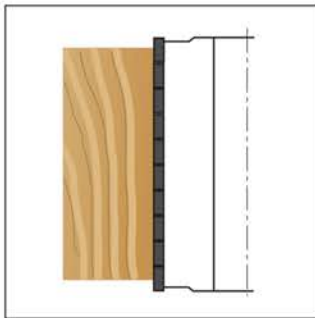
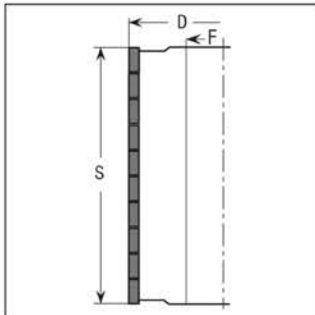
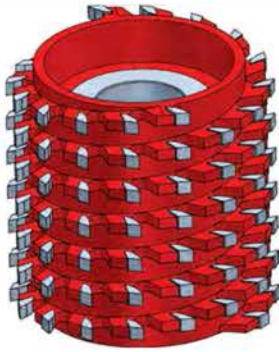

● = Ready in stock   ■ = Delivery time 20 working days   △ = On request

D	S	Div.	F	BRAND
120	60	10	40	■ SUNMORE
120	80	10	40	■ SUNMORE
120	100	10	40	■ SUNMORE
120	120	10	40	■ SUNMORE
120	140	10	40	■ SUNMORE
120	160	10	40	■ SUNMORE
120	180	10	40	■ SUNMORE
140	60	10	40	■ SUNMORE
140	80	10	40	■ SUNMORE
140	100	10	40	■ SUNMORE
140	120	10	40	■ SUNMORE
140	140	10	40	■ SUNMORE
140	160	10	40	■ SUNMORE
140	180	10	40	■ SUNMORE
120	60	12	40	■ SUNMORE
120	80	12	40	■ SUNMORE
120	100	12	40	● SUNMORE
120	120	12	40	■ SUNMORE
120	140	12	40	■ SUNMORE
120	160	12	40	■ SUNMORE
120	180	12	40	■ SUNMORE
120	230	12	40	■ SUNMORE
125	60	12	40	■ SUNMORE
125	80	12	40	■ SUNMORE
125	100	12	40	■ SUNMORE
125	120	12	40	■ SUNMORE
125	140	12	40	■ SUNMORE
125	160	12	40	■ SUNMORE
125	180	12	40	■ SUNMORE
125	200	12	40	■ SUNMORE
125	230	12	40	■ SUNMORE
125	240	12	40	■ SUNMORE

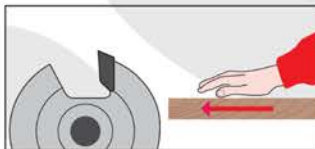
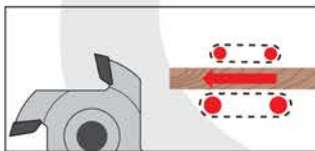
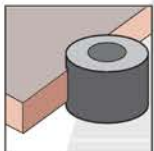
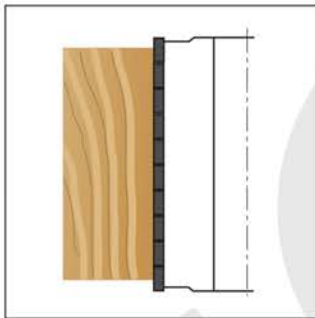
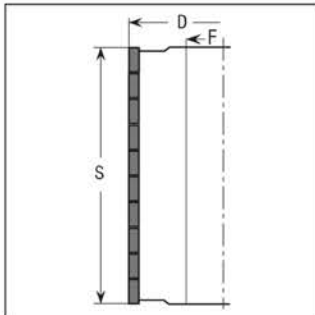
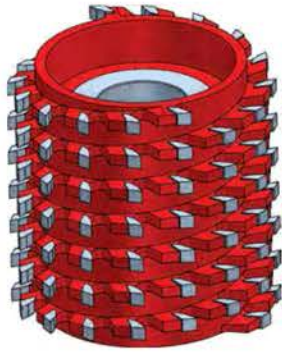

● = Ready in stock   ■ = Delivery time 20 working days   △ = On request

D	S	Div.	F	BRAND
140	60	12	40	■ SUNMORE
140	80	12	40	■ SUNMORE
140	100	12	40	■ SUNMORE
140	120	12	40	■ SUNMORE
140	140	12	40	■ SUNMORE
140	160	12	40	■ SUNMORE
140	180	12	40	■ SUNMORE
140	200	12	40	■ SUNMORE
140	230	12	40	■ SUNMORE
140	240	12	40	■ SUNMORE
120	60	16*	40	■ SUNMORE
120	80	16*	40	■ SUNMORE
120	100	16*	40	■ SUNMORE
120	120	16*	40	■ SUNMORE
120	140	16*	40	■ SUNMORE
120	160	16*	40	■ SUNMORE
120	180	16*	40	■ SUNMORE
120	230	16*	40	■ SUNMORE
125	60	16*	40	■ SUNMORE
125	80	16*	40	● SUNMORE
125	100	16*	40	■ SUNMORE
125	120	16*	40	● SUNMORE
125	140	16*	40	■ SUNMORE
125	160	16*	40	■ SUNMORE
125	180	16*	40	■ SUNMORE
125	200	16*	40	■ SUNMORE
125	230	16*	40	● SUNMORE
140	60	16*	40	■ SUNMORE
140	80	16*	40	■ SUNMORE
140	100	16*	40	■ SUNMORE
140	120	16*	40	■ SUNMORE
140	140	16*	40	■ SUNMORE
140	160	16*	40	■ SUNMORE
140	180	16*	40	■
140	230	16*	40	■

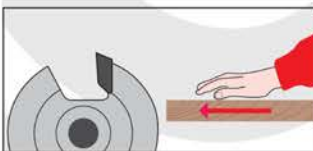
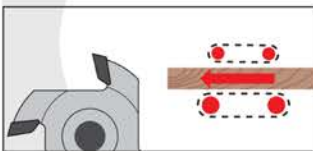
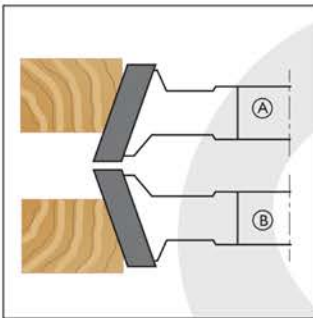
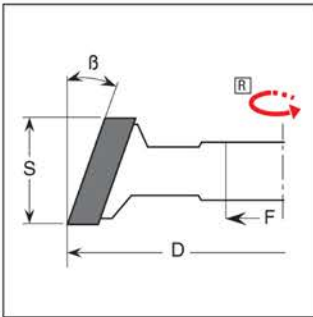

Z=4

● = Ready in stock    ■ = Delivery time 20 working days    △ = On request

D	S	B max	F	BRAND
120	20	45°	30	■ SUNMORE
120	25	38°	30	■ SUNMORE
120	30	33°	30	■ SUNMORE
120	35	29°	30	■ SUNMORE
120	40	26°	30	■ SUNMORE
120	50	21°	30	■ SUNMORE
160	20	45°	30	■ SUNMORE
160	25	45°	30	■ SUNMORE
160	30	45°	30	■ SUNMORE
160	35	45°	30	■ SUNMORE
160	40	41°	30	■ SUNMORE
160	50	35°	30	■ SUNMORE
160	60	30°	30	■ SUNMORE
160	70	26°	30	■ SUNMORE
200	20	45°	40	■ SUNMORE
200	25	45°	40	■ SUNMORE
200	30	45°	40	■ SUNMORE
200	35	45°	40	■ SUNMORE
200	40	45°	40	■ SUNMORE
200	50	45°	40	■ SUNMORE
200	60	39°	40	■ SUNMORE
200	70	35°	40	■ SUNMORE
200	80	32°	40	■ SUNMORE

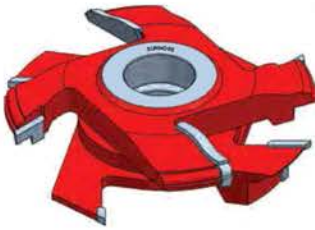

Z=2+2+2+2

● = Ready in stock ■ = Delivery time 20 working days △ = On request

D	F	BRAND
180	40	■ SUNMORE

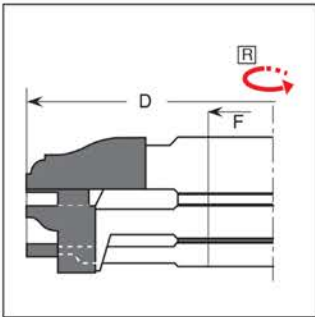

SPARE PARTS

Type	Dimensions	BRAND
Top cutter	180X26	■ SUNMORE
Middle cutter	180X25	■ SUNMORE
Bottom cutter	180X5	■ SUNMORE

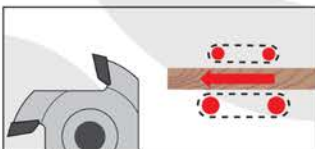
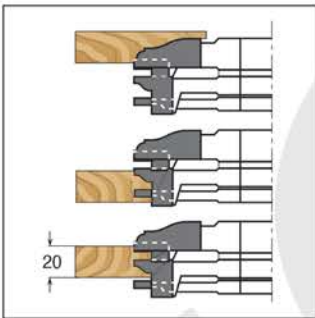

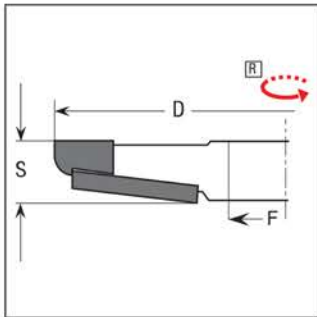
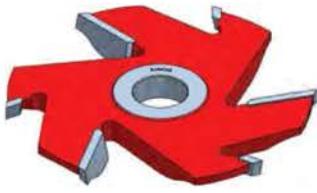

● = Ready in stock    ■ = Delivery time 20 working days    △ = On request

D	S	F	Z	BRAND
200	20	40	3	■ SUNMORE
200	20	40	4	■ SUNMORE
200	20	40	6	■ SUNMORE
200	20	40	3+3	■ SUNMORE
200	20	40	4+4	■ SUNMORE

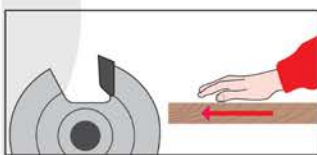
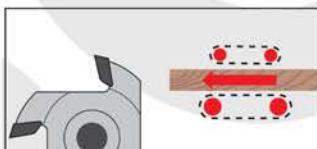
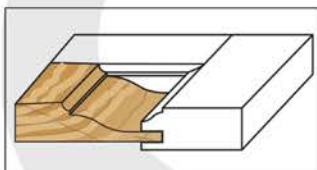
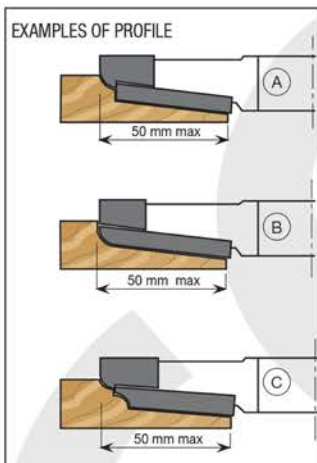

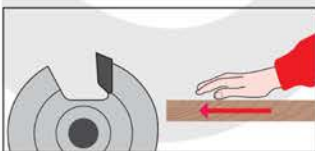
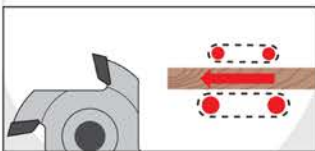
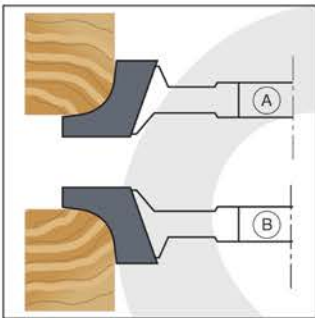
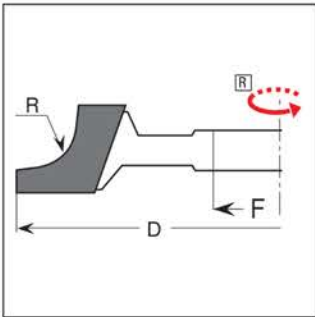
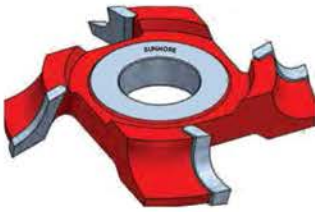

Z=4

● = Ready in stock    ■ = Delivery time 20 working days    △ = On request

D	R	F	BRAND		
120	5	30	■ SUNMORE		
120	10	30	■ SUNMORE		
120	15	30	■ SUNMORE		
120	20	30	■ SUNMORE		
140	5	30	■ SUNMORE		
140	10	30	■ SUNMORE		
140	15	30	■ SUNMORE		
140	20	30	■ SUNMORE		
140	25	30	■ SUNMORE		
160	5	30	■ SUNMORE		
160	10	30	■ SUNMORE		
160	15	30	■ SUNMORE		
160	20	30	■ SUNMORE		
160	25	30	■ SUNMORE		
160	30	30	■ SUNMORE		

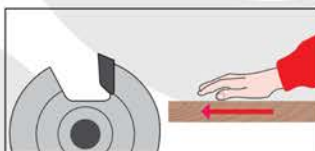
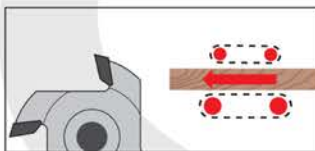
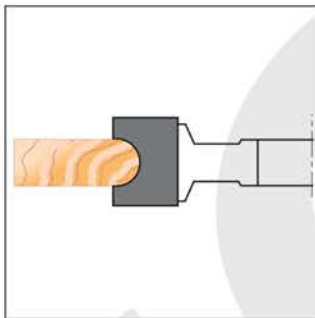
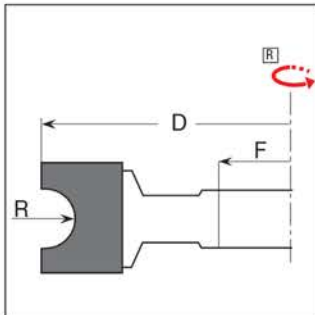
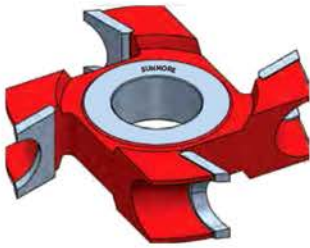

Z=4

● = Ready in stock    ■ = Delivery time 20 working days    △ = On request

D	R	F	BRAND
120	5	30	■ SUNMORE
120	10	30	■ SUNMORE
120	15	30	■ SUNMORE
120	20	30	■ SUNMORE
140	5	30	■ SUNMORE
140	10	30	■ SUNMORE
140	15	30	■ SUNMORE
140	20	30	■ SUNMORE
140	25	30	■ SUNMORE
160	5	30	■ SUNMORE
160	10	30	■ SUNMORE
160	15	30	■ SUNMORE
160	20	30	■ SUNMORE
160	25	30	■ SUNMORE
160	30	30	■ SUNMORE

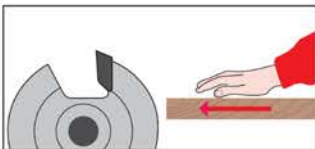
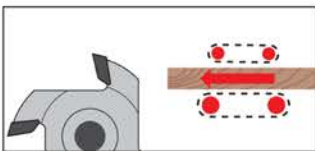
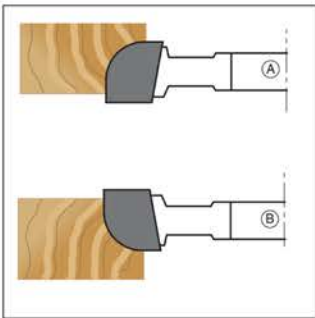
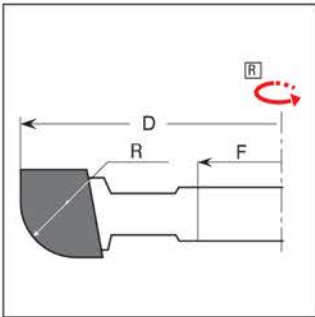
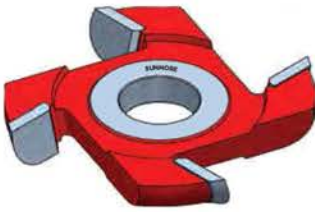

Z=4

● = Ready in stock   ■ = Delivery time 20 working days   △ = On request

D	R	F	BRAND		
120	5	30	■ SUNMORE		
120	10	30	■ SUNMORE		
120	15	30	■ SUNMORE		
120	20	30	■ SUNMORE		
140	5	30	■ SUNMORE		
140	10	30	■ SUNMORE		
140	15	30	■ SUNMORE		
140	20	30	■ SUNMORE		
140	25	30	■ SUNMORE		
160	5	30	■ SUNMORE		
160	10	30	■ SUNMORE		
160	15	30	■ SUNMORE		
160	20	30	■ SUNMORE		
160	25	30	■ SUNMORE		
160	30	30	■ SUNMORE		



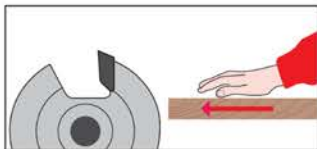
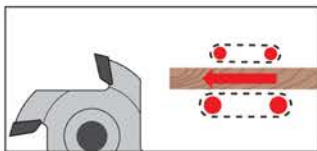
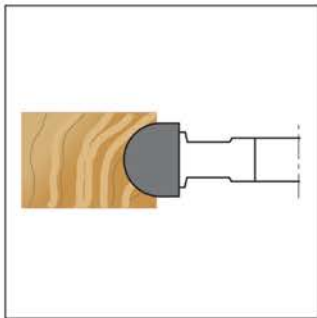
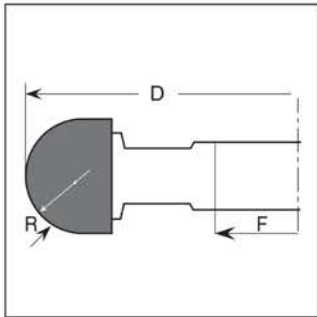

Z=4

● = Ready in stock   ■ = Delivery time 20 working days   △ = On request

D	R	F	BRAND
120	5	30	■ SUNMORE
120	10	30	■ SUNMORE
120	15	30	■ SUNMORE
120	20	30	■ SUNMORE
140	5	30	■ SUNMORE
140	10	30	■ SUNMORE
140	15	30	■ SUNMORE
140	20	30	■ SUNMORE
140	25	30	■ SUNMORE
160	5	30	■ SUNMORE
160	10	30	■ SUNMORE
160	15	30	■ SUNMORE
160	20	30	■ SUNMORE
160	25	30	■ SUNMORE
160	30	30	■ SUNMORE

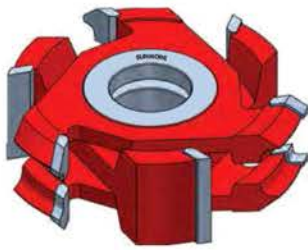

**Z=3+3+3**

● = Ready in stock   ■ = Delivery time 20 working days   △ = On request

D	S	F	BRAND
140	10÷55	30	■ SUNMORE

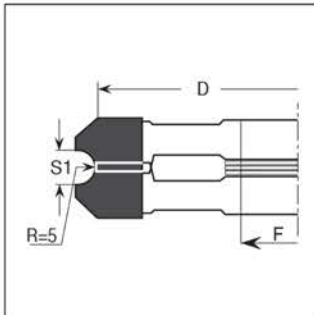

SPARE PARTS

Type	Dimensions	BRAND
Top cutter	154X20	■ SUNMORE
Middle cutter	140X50	■ SUNMORE
Bottom cutter	154X20	■ SUNMORE

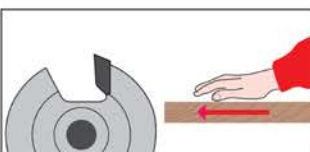
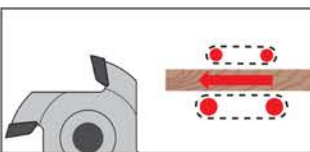
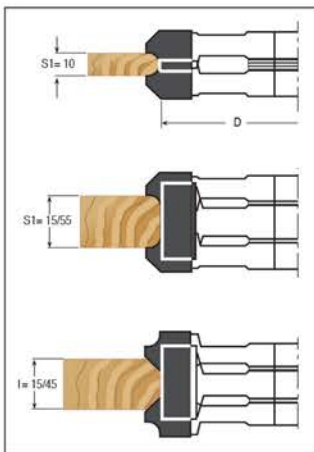

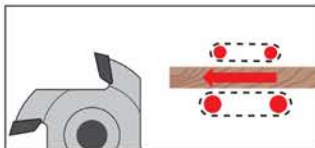
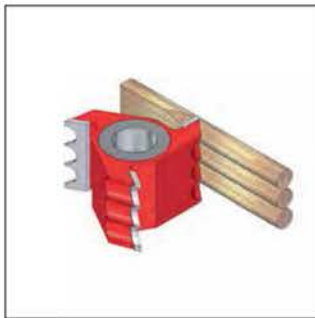
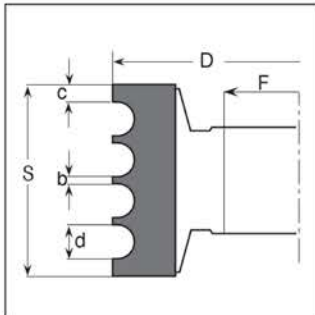
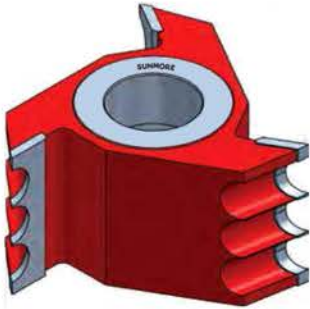

Z=3

● = Ready in stock

■ = Delivery time 20 working days

△ = On request

D	S	d	b	c	Sticks	F	BRAND
120	19	5	1	4	2	40	△ SUNMORE
120	21	6	1	4	2	40	△ SUNMORE
120	25	8	1	4	2	40	△ SUNMORE
120	31	10	1	4	2	40	△ SUNMORE
120	35,5	12	1,5	5	2	40	△ SUNMORE
120	39,5	14	1,5	5	2	40	△ SUNMORE
140	43,5	16	1,5	5	2	40	△ SUNMORE
140	47,5	18	1,5	5	2	40	△ SUNMORE
140	52	20	1,5	5	2	40	△ SUNMORE
120	25	5	1	4	3	40	△ SUNMORE
120	28	6	1	4	3	40	△ SUNMORE
120	34	8	1	4	3	40	△ SUNMORE
120	42	10	1	4	3	40	△ SUNMORE
120	49	12	1,5	5	3	40	△ SUNMORE
120	55	14	1,5	5	3	40	△ SUNMORE
140	61	16	1,5	5	3	40	△ SUNMORE
140	67	18	1,5	5	3	40	△ SUNMORE
140	74	20	2	5	3	40	△ SUNMORE
120	31	5	1	4	4	40	△ SUNMORE
120	35	6	1	4	4	40	△ SUNMORE
120	43	8	1	4	4	40	△ SUNMORE
120	53	10	1	5	4	40	△ SUNMORE
120	62,5	12	1,5	5	4	40	△ SUNMORE
120	70,5	14	1,5	5	4	40	△ SUNMORE
140	78,5	16	1,5	5	4	40	△ SUNMORE
140	86,5	18	1,5	5	4	40	△ SUNMORE
140	96	20	2	5	4	40	△ SUNMORE
120	37	5	1	4	5	40	△ SUNMORE
120	42	6	1	4	5	40	△ SUNMORE
120	52	8	1	4	5	40	△ SUNMORE

## NOTE

■ Utensili non a magazzino, quantità minima d'ordine: 1 pezzo.  
Tools not ready in stock minimum order quantity: 1 piece.

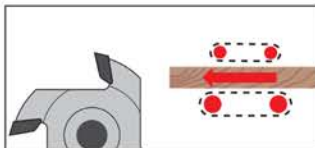
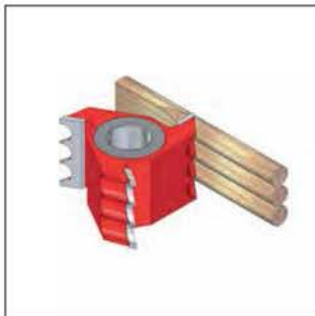
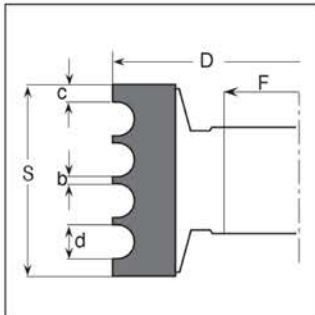
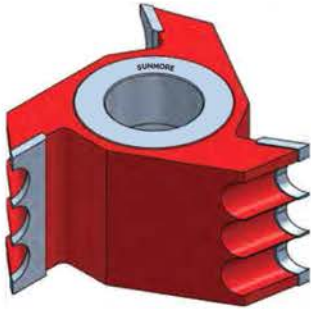

**Z=3**

● = Ready in stock   ■ = Delivery time 20 working days   △ = On request

D	S	d	b	c	Sticks	F	BRAND
120	64	10	1	5	5	40	△ SUNMORE
120	76	12	1,5	5	5	40	△ SUNMORE
120	86	14	1,5	5	5	40	△ SUNMORE
140	96	16	1,5	5	5	40	△ SUNMORE
140	106	18	1,5	5	5	40	△ SUNMORE
140	118	20	2	5	5	40	△ SUNMORE
120	43	5	1	4	6	40	△ SUNMORE
120	49	6	1	4	6	40	△ SUNMORE
120	61	8	1	4	6	40	△ SUNMORE
120	75	10	1	5	6	40	△ SUNMORE
120	89,5	12	1,5	5	6	40	△ SUNMORE
120	101,5	14	1,5	5	6	40	△ SUNMORE
140	113,5	16	1,5	5	6	40	△ SUNMORE
140	125,5	18	1,5	5	6	40	△ SUNMORE
140	140	20	2	5	6	40	△ SUNMORE
120	49	5	1	4	7	40	△ SUNMORE
120	56	6	1	4	7	40	△ SUNMORE
120	70	8	1	4	7	40	△ SUNMORE
120	86	10	1	5	7	40	△ SUNMORE
120	103	12	1,5	5	7	40	△ SUNMORE
120	117	14	1,5	5	7	40	△ SUNMORE
140	131	16	1,5	5	7	40	△ SUNMORE
140	145	18	1,5	5	7	40	△ SUNMORE
120	55	5	1	4	8	40	△ SUNMORE
120	63	6	1	4	8	40	△ SUNMORE
120	79	8	1	4	8	40	△ SUNMORE
120	97	10	1	5	8	40	△ SUNMORE
120	116,5	12	1,5	5	8	40	△ SUNMORE
120	132,5	14	1,5	5	8	40	△ SUNMORE
140	148,5	16	1,5	5	8	40	△ SUNMORE

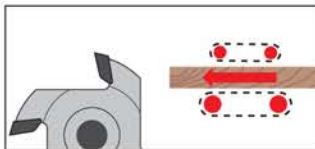
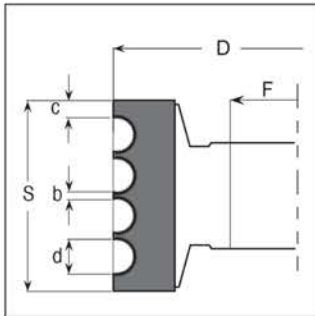
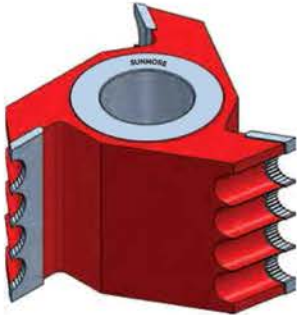

Z=3

● = Ready in stock   ■ = Delivery time 20 working days   △ = On request

D	S	d	b	c	Sticks	F	BRAND
120	19,4	5,2	1	4	2	40	△ SUNMORE
120	21,4	6,2	1	4	2	40	△ SUNMORE
120	25,4	8,2	1	4	2	40	△ SUNMORE
120	31,4	10,2	1	5	2	40	△ SUNMORE
120	35,9	12,2	1,5	5	2	40	△ SUNMORE
120	39,9	14,2	1,5	5	2	40	△ SUNMORE
120	25,6	5,2	1	4	3	40	△ SUNMORE
120	28,6	6,2	1	4	3	40	△ SUNMORE
120	34,6	8,2	1	4	3	40	△ SUNMORE
120	42,6	10,2	1	4	3	40	△ SUNMORE
120	49,6	12,2	1,5	5	3	40	△ SUNMORE
120	55,6	14,2	1,5	5	3	40	△ SUNMORE
120	31,8	5,2	1	4	4	40	△ SUNMORE
120	35,8	6,2	1	4	4	40	△ SUNMORE
120	43,8	8,2	1	4	4	40	△ SUNMORE
120	53,8	10,2	1	4	4	40	△ SUNMORE
120	63,3	12,2	1,5	5	4	40	△ SUNMORE
120	71,3	14,2	1,5	5	4	40	△ SUNMORE
120	38	5,2	1	4	5	40	△ SUNMORE
120	43	6,2	1	4	5	40	△ SUNMORE
120	53	8,2	1	4	5	40	△ SUNMORE

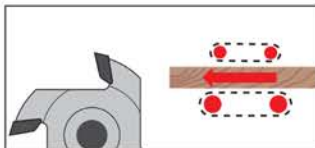
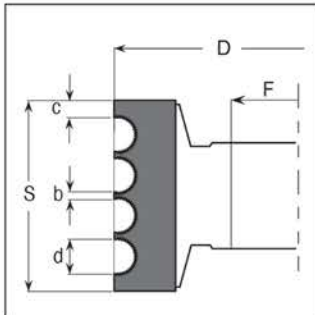
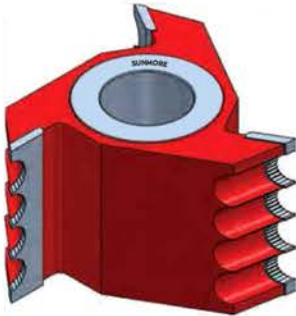

**Z=3**

● = Ready in stock   ■ = Delivery time 20 working days   △ = On request

D	S	d	b	c	Sticks	F	BRAND
120	65	10,2	1	5	5	40	△ SUNMORE
120	77	12,2	1,5	5	5	40	△ SUNMORE
120	87	14,2	1,5	5	5	40	△ SUNMORE
120	44,2	5,2	1	4	6	40	△ SUNMORE
120	50,2	6,2	1	4	6	40	△ SUNMORE
120	62,2	8,2	1	4	6	40	△ SUNMORE
120	76,2	10,2	1	5	6	40	△ SUNMORE
120	90,7	12,2	1,5	5	6	40	△ SUNMORE
120	102,7	14,2	1,5	5	6	40	△ SUNMORE
120	50,4	5,2	1	4	7	40	△ SUNMORE
120	57,4	6,2	1	4	7	40	△ SUNMORE
120	71,4	8,2	1	4	7	40	△ SUNMORE
120	87,4	10,2	1	5	7	40	△ SUNMORE
120	104,4	12,2	1,5	5	7	40	△ SUNMORE
120	118,4	14,2	1,5	5	7	40	△ SUNMORE
120	56,6	5,2	1	4	8	40	△ SUNMORE
120	64,6	6,2	1	4	8	40	△ SUNMORE
120	80,6	8,2	1	4	8	40	△ SUNMORE
120	102,1	10,2	1,5	5	8	40	△ SUNMORE
120	118,1	12,2	1,5	5	8	40	△ SUNMORE
120	134,1	14,2	1,5	5	8	40	△ SUNMORE

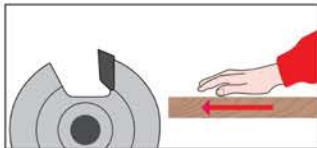
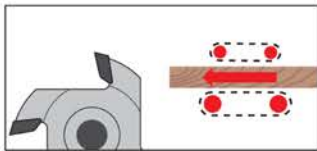
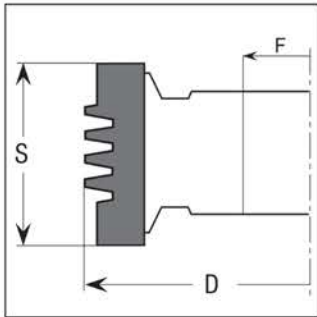
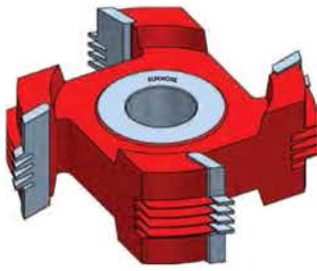

Z=4

● = Ready in stock   ■ = Delivery time 20 working days   △ = On request

D	S	Profile	F	BRAND
140	40	A	40	■ SUNMORE
140	50	B	40	■ SUNMORE
140	60	C	40	■ SUNMORE
140	40	D	40	■ SUNMORE
140	50	E	40	■ SUNMORE
140	60	F	40	■ SUNMORE
140	40	G	40	■ SUNMORE
140	50	H	40	■ SUNMORE
140	60	I	40	■ SUNMORE

NOTE

■ Utensili non a magazzino, quantità minima d'ordine: 1 pezzo.  
Tools not ready in stock minimum order quantity: 1 piece.

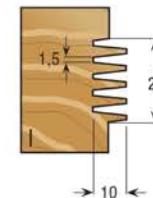
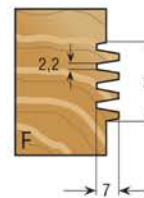
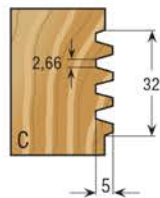
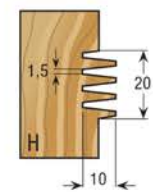
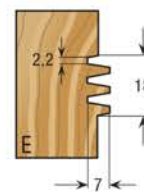
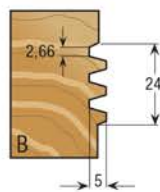
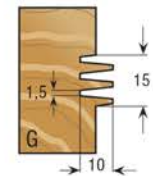
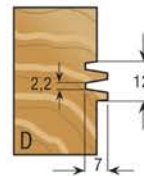
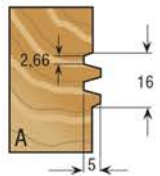

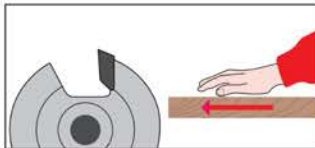
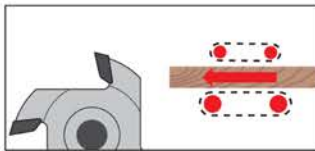
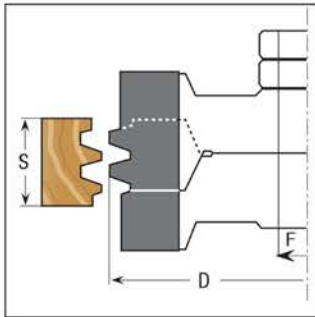
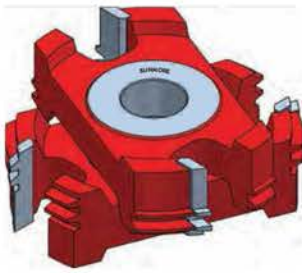

Z=2+2

● = Ready in stock   ■ = Delivery time 20 working days   △ = On request

D	S min.	S max	Profile	F	BRAND
140	20	60	A	40	■ SUNMORE
140	16	60	B	40	■ SUNMORE

**NOTE**

■ Utensili non a magazzino, quantità minima d'ordine: 1 pezzo.  
Tools not ready in stock minimum order quantity: 1 piece.

Il prezzo include anelli di regolazione.  
The price included spacing collars.

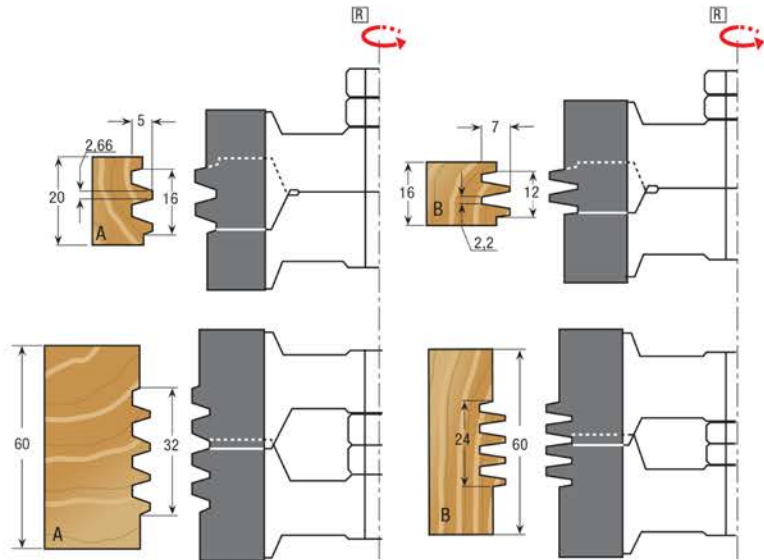



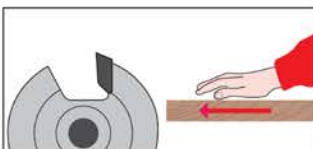
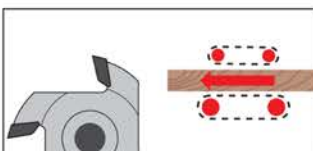
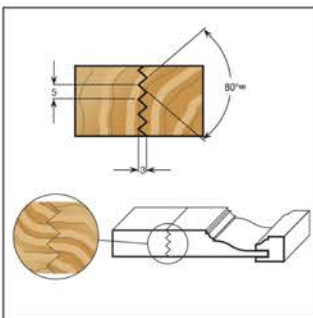
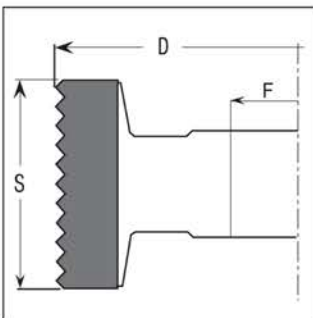
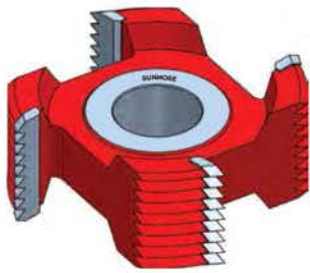

Z=4

● = Ready in stock   ■ = Delivery time 20 working days   △ = On request

D	S	F	BRAND
140	50	40	■ SUNMORE
140	85	40	■ SUNMORE

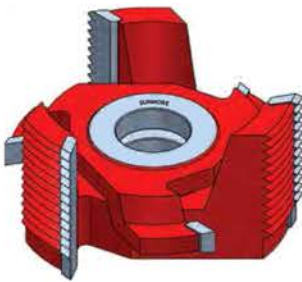

**Z=3+3**

● = Ready in stock   ■ = Delivery time 20 working days   △ = On request

D	S	Profile	F	BRAND
140	80	A	40	■ SUNMORE
140	80	B	40	■ SUNMORE

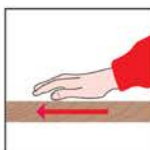
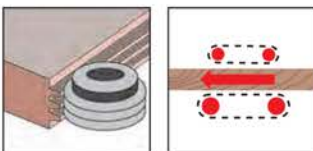
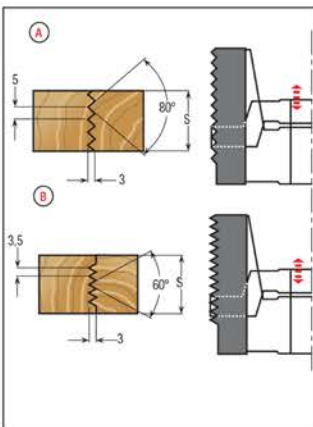
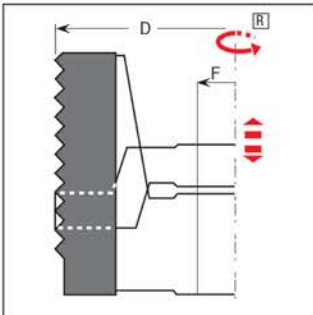

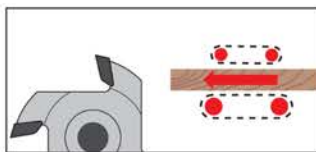
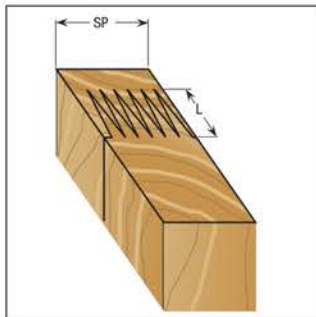
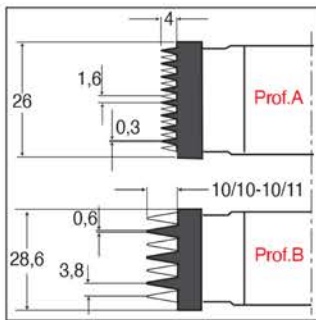
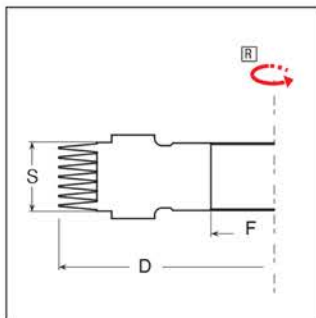

● = Ready in stock   ■ = Delivery time 20 working days   △ = On request

D	S	F	Z	Profile	L	BRAND
160	26	50	2+2	A	4	△ SUNMORE
160	28,6	50	2+2	B	10/10	△ SUNMORE
160	28,6	50	2+2	B	10/11	△ SUNMORE
250	28,6	50	3+3	B	10/10	△ SUNMORE
250	28,6	50	3+3	B	10/11	△ SUNMORE

**NOTE**

■ Utensili non a magazzino, quantità minima d'ordine: 1 pezzo.  
Tools not ready in stock minimum order quantity: 1 piece.

Profile	L	SP	n. cutters
A	4	25	1
A	4	49	2
A	4	73	3
A	4	97	4
A	4	121	5
A	4	145	6
A	4	169	7
A	4	193	8
A	4	217	9
A	4	241	10
B	10	24	1
B	10	51	2
B	10	77	3
B	10	104	4
B	10	131	5
B	10	157	6
B	10	184	7
B	10	210	8
B	10	237	9
B	10	264	10

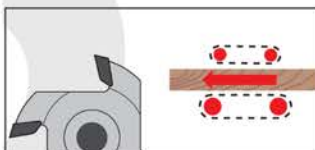
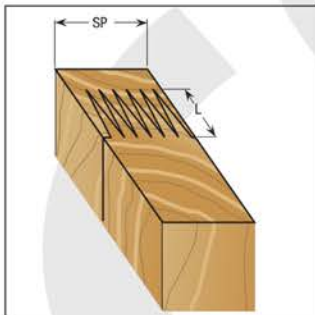
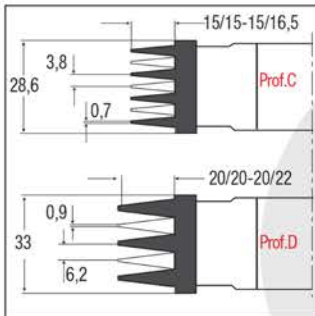
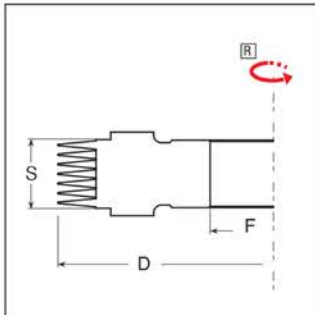

● = Ready in stock   ■ = Delivery time 20 working days   △ = On request

D	S	F	Z	Profile	L	BRAND
170	28,6	50	2+2	C	15/15	△ SUNMORE
170	28,6	50	2+2	C	15/16,5	△ SUNMORE
260	28,6	50	3+3	C	15/15	△ SUNMORE
260	28,6	50	3+3	C	15/16,5	△ SUNMORE
180	33	50	2+2	D	20/20	△ SUNMORE
180	33	50	2+2	D	20/22	△ SUNMORE
260	33	50	3+3	D	20/22	△ SUNMORE

**NOTE**

■ Utensili non a magazzino, quantità minima d'ordine: 1 pezzo.  
Tools not ready in stock minimum order quantity: 1 piece.

Profile	L	SP	n. cutters
C	15	24	1
C	15	51	2
C	15	77	3
C	15	104	4
C	15	131	5
C	15	157	6
C	15	184	7
C	15	210	8
C	15	237	9
C	15	264	10
D	20	28	1
D	20	59	2
D	20	90	3
D	20	121	4
D	20	152	5
D	20	183	6
D	20	214	7
D	20	245	8
D	20	276	9
D	20	307	10

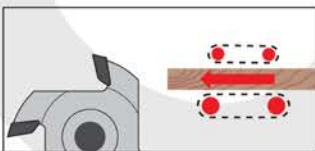
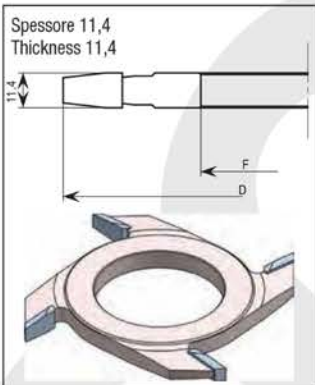
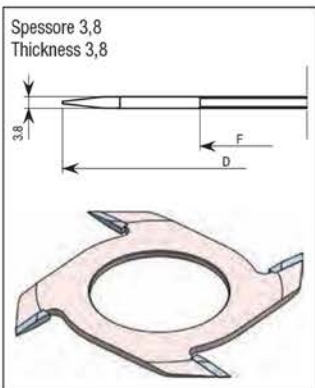
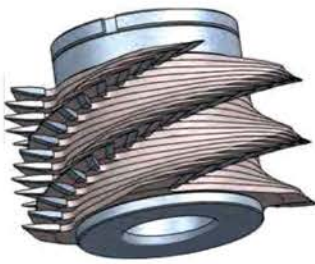

**Z=4/6**

● = Ready in stock

■ = Delivery time 20 working days

△ = On request

D	S	F	Z	L	BRAND
160	3,8	70	4	10/11	△ SUNMORE
250	3,8	70	6	10/11	△ SUNMORE
160	11,4	70	4	10/11	△ SUNMORE
250	11,4	70	6	10/11	△ SUNMORE

**NOTE**

■ Utensili non a magazzino, quantità minima d'ordine: 1 pezzo.  
Tools not ready in stock minimum order quantity: 1 piece.

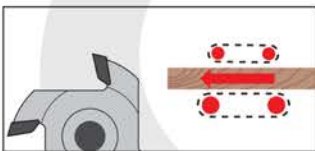
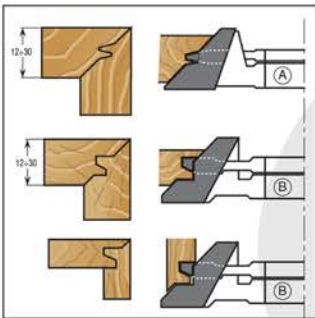
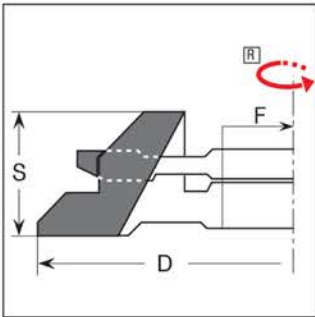
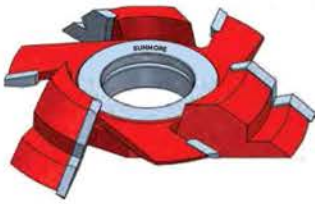

**Z=3+3**

● = Ready in stock    ■ = Delivery time 20 working days    △ = On request

D	S	F	Z	Mod.	BRAND
160	35	40	3+3	A	■ SUNMORE
180	35	40	3+3	A	■ SUNMORE
160	35	40	3+3	B	■ SUNMORE
180	35	40	3+3	B	■ SUNMORE

\* Al momento dell'ordine specificare il modello di fresa: A o B  
 \* When ordering, specify the type of cutter: A or B

**NOTE**

■ Utensili non a magazzino, quantità minima d'ordine: 1 pezzo.  
 Tools not ready in stock minimum order quantity: 1 piece.

Il prezzo include anelli di regolazione.  
 The price included spacing collars.

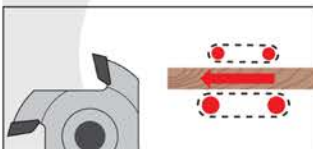
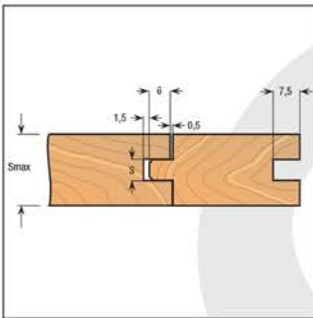
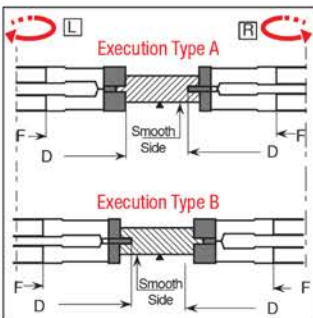
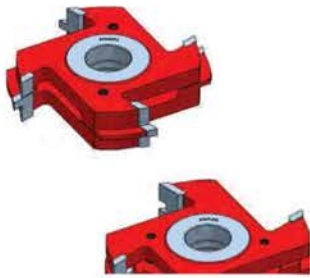

Z=4

● = Ready in stock ■ = Delivery time 20 working days △ = On request

D	S	S Max	Mod.	F	BRAND
160	4÷7,5	20	A	40	△ SUNMORE
160	4÷7,5	20	B	40	△ SUNMORE

**NOTE**

■ Utensili non a magazzino, quantità minima d'ordine: 1 pezzo.  
Tools not ready in stock minimum order quantity: 1 piece.

Il prezzo include anelli di regolazione.  
The price included spacing collars.

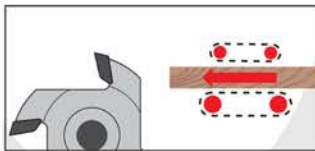
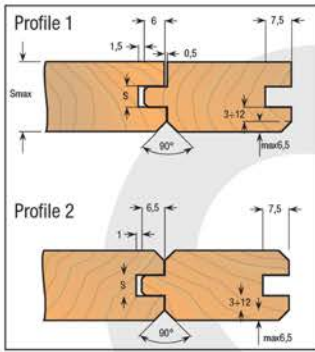
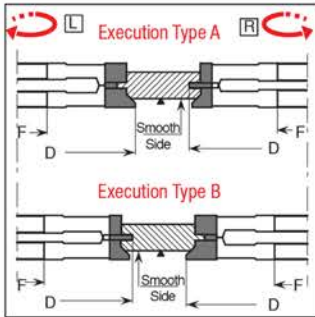
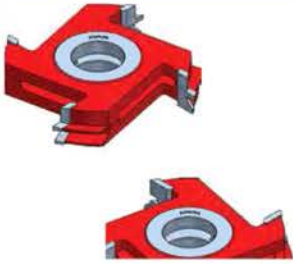

Z=4

● = Ready in stock ■ = Delivery time 20 working days △ = On request

D	S	S Max	Mod.	Prof.	F	BRAND
160	4÷7,5	20	A	1	40	△ SUNMORE
160	4÷7,5	20	B	1	40	△ SUNMORE
160	4÷7,5	20	A	2	40	△ SUNMORE
160	4÷7,5	20	B	2	40	△ SUNMORE
160	6÷11	30	A	1	40	△ SUNMORE
160	6÷11	30	B	1	40	△ SUNMORE
160	6÷11	30	A	2	40	△ SUNMORE
160	6÷11	30	B	2	40	△ SUNMORE

**NOTE**

■ Utensili non a magazzino, quantità minima d'ordine: 1 pezzo.  
Tools not ready in stock minimum order quantity: 1 piece.

Il prezzo include anelli di regolazione.  
The price included spacing collars.



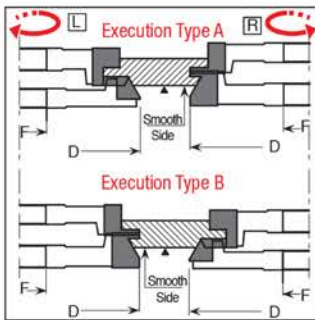

Z=4 V=4

● = Ready in stock ■ = Delivery time 20 working days △ = On request

D	S	S Max	Mod.	Prof.	F	BRAND
160	4÷7,5	20	A	1	40	△ SUNMORE
160	4÷7,5	20	B	1	40	△ SUNMORE
160	4÷7,5	20	A	2	40	△ SUNMORE
160	4÷7,5	20	B	2	40	△ SUNMORE
160	6÷11	30	A	1	40	△ SUNMORE
160	6÷11	30	B	1	40	△ SUNMORE
160	6÷11	30	A	2	40	△ SUNMORE
160	6÷11	30	B	2	40	△ SUNMORE

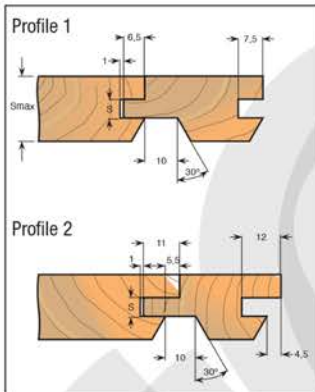

**NOTE**

■ Utensili non a magazzino, quantità minima d'ordine: 1 pezzo.  
Tools not ready in stock minimum order quantity: 1 piece.

Il prezzo include anelli di regolazione.  
The price included spacing collars.

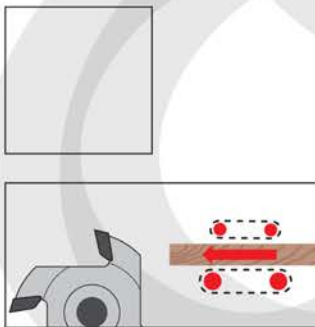



 P050 p. 387	 P053 p. 388	 P054 p. 389	 P056 p. 390	 P057 p. 391	 P058 p. 392	 P059 p. 393
 P060 p. 394	 P062 p. 395	 P064 p. 396	 P066 p. 397	 P067 p. 398	 P068 p. 399	 P069 p. 401
 P070 p. 402	 P071 p. 403	 P072 p. 404	 P080 p. 405	 P400 p. 406	 P401 p. 407	 P094 p. 408
 P095 p. 409	 P100 p. 410	 P104 p. 411	 P105 p. 412	 P107 p. 413	 P108 p. 414-415	 P109 p. 416
 P111 p. 417	 P410 p. 418	 P610 p. 419	 P618 p. 420	 P620 p. 421	 P414 p. 422	 P614 p. 423
 P118 p. 424	 P127 p. 425	 P120 p. 426	 P122 p. 427	 P124 p. 428	 P121 p. 429	 P123 p. 430
 P125 p. 431	 P134 p. 432	 P136 p. 433	 P140 p. 434	 P160 p. 435	 P560 p. 436	 P562 p. 437
 P170 p. 438	 P172 p. 439	 P185 p. 440	 P351 p. 441	 P381-P383 p. 442	 P385 p. 443	 PCB1-PCB2



MŨI KHOAN TCT - BP

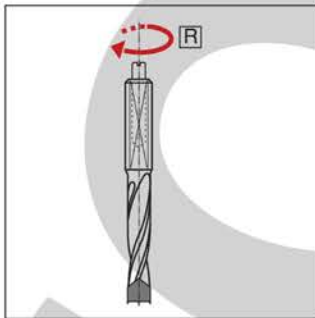
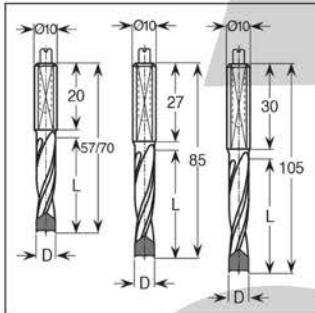

Affilatura con incisore negativo  
Sharpening with negative spurs

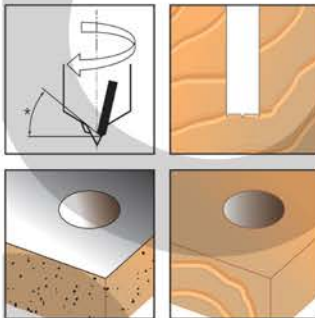

Utensili non a magazzino, quantità minima d'ordine: 20 pezzi.  
Tools not ready in stock minimum order quantity: 20 pieces.

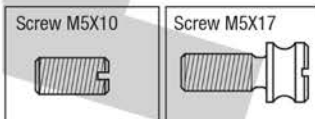

● = Ready in stock ■ = Delivery time 20 working days △ = On request

D	L	LT	BRAND
4	27	57,5	● SUNMORE
4,5	27	57,5	● SUNMORE
5	30	57,5	● SUNMORE
6	30	57,5	● SUNMORE
7	30	57,5	● SUNMORE
8	30	57,5	● SUNMORE
8,5	30	57,5	● SUNMORE
9	30	57,5	● SUNMORE
10	30	57,5	● SUNMORE
12	30	57,5	● SUNMORE
14	30	57,5	● SUNMORE
15	30	57,5	● SUNMORE
16	30	57,5	● SUNMORE
4	40	70	● SUNMORE
4,5	40	70	● SUNMORE
5	43	70	● SUNMORE
6	43	70	● SUNMORE
7	43	70	● SUNMORE
8	43	70	● SUNMORE
8,5	43	70	● SUNMORE
9	43	70	● SUNMORE
10	43	70	● SUNMORE
12	43	70	● SUNMORE
14	43	70	● SUNMORE
15	43	70	● SUNMORE
16	43	70	● SUNMORE

LONG SPIRAL

D	L	LT	BRAND
5	50	85	● SUNMORE
6	50	85	● SUNMORE
8	50	85	● SUNMORE
10	50	85	● SUNMORE
12	50	85	● SUNMORE
5	65	105	● SUNMORE
6	65	105	● SUNMORE
8	65	105	● SUNMORE
10	65	105	● SUNMORE
12	65	105	● SUNMORE



MŨI KHOAN TCT - BP

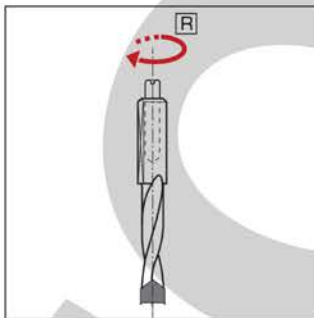
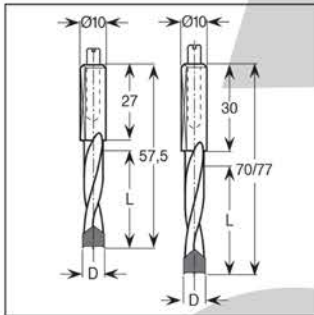

Affilatura con incisore negativo  
Sharpening with negative spurs

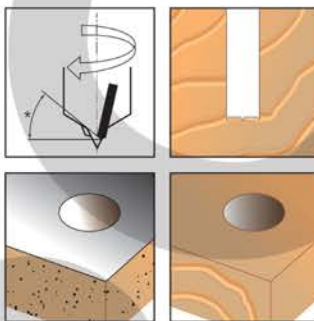

■ Utensili non a magazzino, quantità minima d'ordine: 20 pezzi.  
Tools not ready in stock minimum order quantity: 20 pieces.

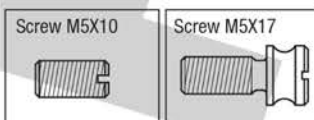

● = Ready in stock ■ = Delivery time 20 working days △ = On request

D	L	LT	BRAND
4	27	57,5	● SUNMORE
5	27	57,5	● SUNMORE
6	27	57,5	● SUNMORE
6,35	27	57,5	● SUNMORE
7	27	57,5	● SUNMORE
8	27	57,5	● SUNMORE
9	27	57,5	● SUNMORE
9,53	27	57,5	● SUNMORE
10	27	57,5	● SUNMORE
11	27	57,5	● SUNMORE
12	27	57,5	● SUNMORE
12,7	27	57,5	● SUNMORE
14	27	57,5	● SUNMORE
15	27	57,5	● SUNMORE
16	27	57,5	● SUNMORE
4	30	70	● SUNMORE
5	35	70	● SUNMORE
6	35	70	● SUNMORE
6,35	35	70	● SUNMORE
7	35	70	● SUNMORE
8	35	70	● SUNMORE
9	35	70	● SUNMORE
9,53	35	70	● SUNMORE
10	35	70	● SUNMORE
11	35	70	● SUNMORE
12	35	70	● SUNMORE
12,7	35	70	● SUNMORE
14	35	70	● SUNMORE
15	35	70	● SUNMORE
16	35	70	● SUNMORE
5	44	77	● SUNMORE
6	44	77	● SUNMORE
7	44	77	● SUNMORE
8	44	77	● SUNMORE
9	44	77	● SUNMORE
10	44	77	● SUNMORE
12	44	77	● SUNMORE



MŨI KHOAN TCT - BP



● = Ready in stock ■ = Delivery time 20 working days △ = On request

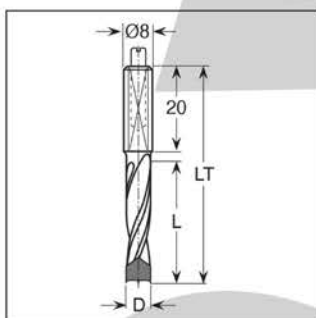

D	L	LT	BRAND
5	30	55,5	● SUNMORE
6	30	55,5	● SUNMORE
7	30	55,5	● SUNMORE
8	30	55,5	● SUNMORE
9	30	55,5	● SUNMORE
10	30	55,5	● SUNMORE
12	30	55,5	● SUNMORE
5	40	67	● SUNMORE
6	40	67	● SUNMORE
7	40	67	● SUNMORE
8	40	67	● SUNMORE
9	40	67	● SUNMORE
10	40	67	● SUNMORE
12	40	67	● SUNMORE

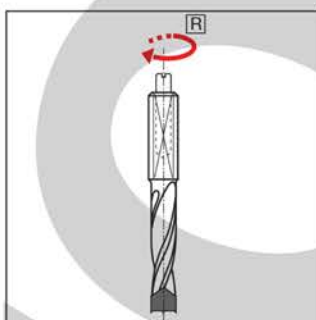

■ Utensili non a magazzino, quantità minima d'ordine: 20 pezzi.  
Tools not ready in stock minimum order quantity: 20 pieces.

Affilatura con incisore negativo  
Sharpening with negative spurs

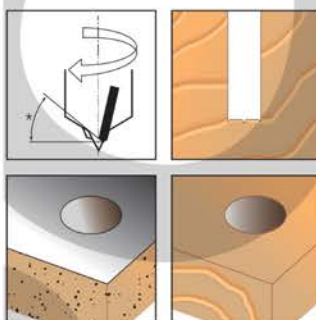

SPARE PARTS

Type	Dimensions	BRAND
Screw	M5X10	SUNMORE
Screw	M5X17	SUNMORE

Chipboard

RPM	Feed Speed
3000	0,8 m/min
4000	1,5 m/min
5000	2 m/min
6000	2,5 m/min
8000	2,8 m/min

MDF-Wood

RPM	Feed Speed
3000	0,6 m/min
4000	1,0 m/min
5000	1,4 m/min
6000	1,8 m/min
8000	2,0 m/min

The data are indicative only, MW is not responsible for any incorrect application

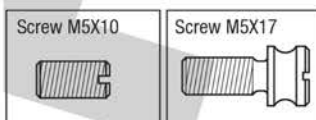



MŨI KHOAN TCT - BP

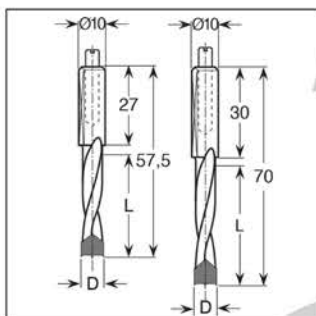

● = Ready in stock ■ = Delivery time 20 working days △ = On request

D	L	LT	BRAND
5	27	57,5	● SUNMORE
6	27	57,5	● SUNMORE
8	27	57,5	● SUNMORE
10	27	57,5	● SUNMORE
5	35	70	● SUNMORE
6	35	70	● SUNMORE
8	35	70	● SUNMORE
10	35	70	● SUNMORE

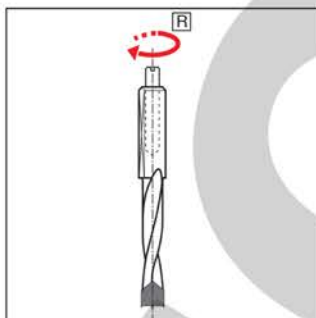

■ Utensili non a magazzino, quantità minima d'ordine: 20 pezzi.  
Tools not ready in stock minimum order quantity: 20 pieces.

SPARE PARTS

Type	Dimensions	BRAND
Screw	M5X10	SUNMORE
Screw	M5X17	SUNMORE

Chipboard

RPM	Feed Speed
3000	1 m/min
4000	1,5 m/min
5000	2 m/min
6000	2,5 m/min
8000	4,0 m/min

MDF-Wood

RPM	Feed Speed
3000	0,7 m/min
4000	1,0 m/min
5000	1,5 m/min
6000	1,8 m/min
8000	2,5 m/min

The data are indicative only, MW is not responsible for any incorrect application

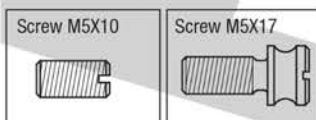
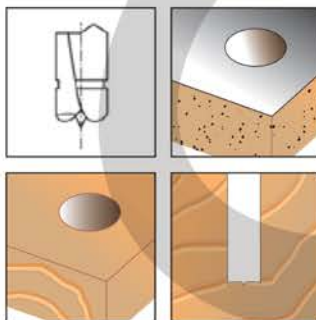



MŨI KHOAN TCT - VP

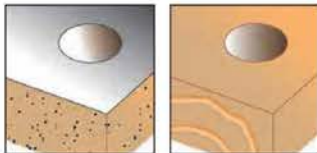
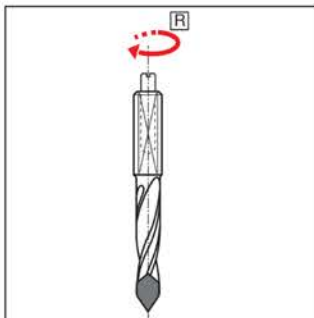
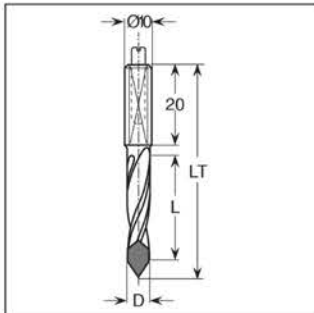

● = Ready in stock ■ = Delivery time 20 working days △ = On request

D	L	LT		BRAND
4,5	27	57,5	●	SUNMORE
5	27	57,5	●	SUNMORE
6	27	57,5	●	SUNMORE
7	27	57,5	●	SUNMORE
8	27	57,5	●	SUNMORE
8,5	27	57,5	●	SUNMORE
10	27	57,5	●	SUNMORE
12	27	57,5	●	SUNMORE
4,5	40	70	●	SUNMORE
5	40	70	●	SUNMORE
6	40	70	●	SUNMORE
7	40	70	●	SUNMORE
8	40	70	●	SUNMORE
8,5	40	70	●	SUNMORE
10	40	70	●	SUNMORE
12	40	70	●	SUNMORE
				SUNMORE
Spec.				SUNMORE

■ Utensili non a magazzino, quantità minima d'ordine: 20 pezzi.  
Tools not ready in stock minimum order quantity: 20 pieces.

SPARE PARTS

Type	Dimensions	BRAND
Screw	M5X10	SUNMORE
Screw	M5X17	SUNMORE

Chipboard

RPM	Feed Speed
3000	0,5 m/min
4000	1,2 m/min
5000	1,5 m/min
6000	1,8 m/min
8000	2,2 m/min

MDF-Wood

RPM	Feed Speed
3000	0,3 m/min
4000	0,8 m/min
5000	1,0 m/min
6000	1,2 m/min
8000	1,7 m/min

The data are indicative only, MW is not responsible for any incorrect application

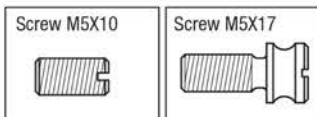



MŨI KHOAN TCT - VP

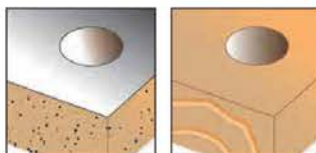
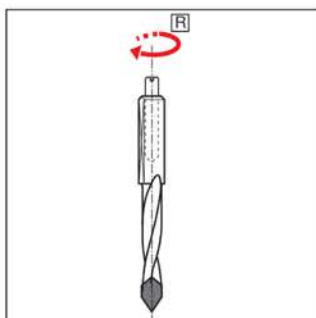
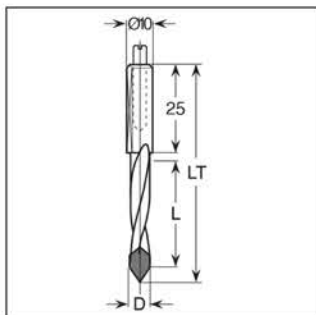

● = Ready in stock ■ = Delivery time 20 working days △ = On request

D	L	LT	BRAND
4	22	57,5	● SUNMORE
5	22	57,5	● SUNMORE
6	22	57,5	● SUNMORE
7	22	57,5	● SUNMORE
8	22	57,5	● SUNMORE
10	22	57,5	● SUNMORE
12	22	57,5	● SUNMORE
4	27	70	● SUNMORE
5	35	70	● SUNMORE
6	35	70	● SUNMORE
7	35	70	● SUNMORE
8	35	70	● SUNMORE
10	35	70	● SUNMORE
12	35	70	● SUNMORE
5	40	77	● SUNMORE
6	40	77	● SUNMORE
8	40	77	● SUNMORE
10	40	77	● SUNMORE
12	40	77	● SUNMORE

■ Utensili non a magazzino, quantità minima d'ordine: 20 pezzi.  
Tools not ready in stock minimum order quantity: 20 pieces.

SPARE PARTS

Type	Dimensions	BRAND
Screw	M5X10	SUNMORE
Screw	M5X17	SUNMORE

Chipboard

RPM	Feed Speed
3000	0,5 m/min
4000	1,2 m/min
5000	1,5 m/min
6000	1,8 m/min
8000	2,2 m/min

MDF-Wood

RPM	Feed Speed
3000	0,3 m/min
4000	0,8 m/min
5000	1,0 m/min
6000	1,2 m/min
8000	1,7 m/min

The data are indicative only, MW is not responsible for any incorrect application

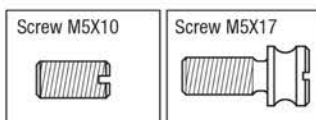





MŨI KHOAN TCT - VP

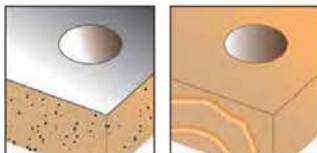
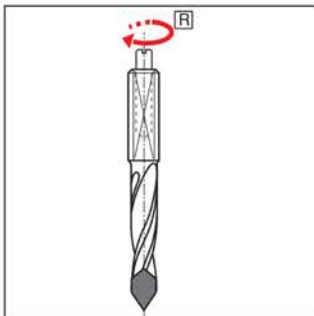
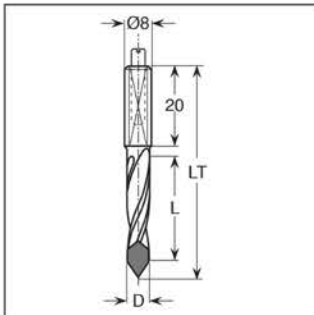

● = Ready in stock ■ = Delivery time 20 working days △ = On request

D	L	LT	BRAND
5	25	55,5	● SUNMORE
6	25	55,5	● SUNMORE
8	25	55,5	● SUNMORE
10	25	55,5	● SUNMORE
5	35	67	● SUNMORE
6	35	67	● SUNMORE
8	35	67	● SUNMORE
10	35	67	● SUNMORE

■ Utensili non a magazzino, quantità minima d'ordine: 20 pezzi.  
Tools not ready in stock minimum order quantity: 20 pieces.

SPARE PARTS

Type	Dimensions	BRAND
Screw	M5X10	SUNMORE
Screw	M5X17	SUNMORE

Chipboard

RPM	Feed Speed
3000	0,5 m/min
4000	1,2 m/min
5000	1,5 m/min
6000	1,8 m/min
8000	2,2 m/min

MDF-Wood

RPM	Feed Speed
3000	0,3 m/min
4000	0,8 m/min
5000	1,0 m/min
6000	1,2 m/min
8000	1,7 m/min

The data are indicative only, MW is not responsible for any incorrect application

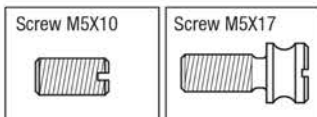

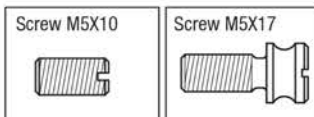
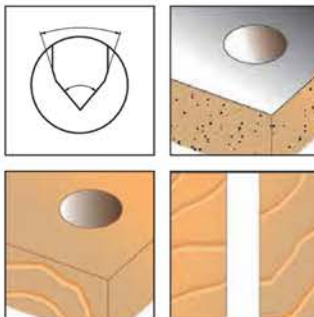
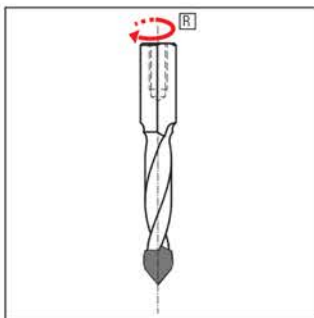
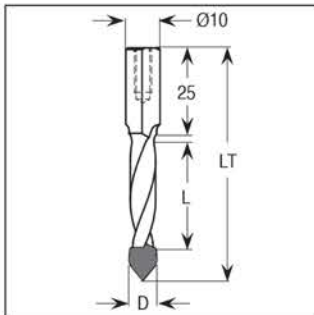

● = Ready in stock   ■ = Delivery time 20 working days   △ = On request

D	L	LT	BRAND	
5	22	57,5	● SUNMORE	●
6	22	57,5	● SUNMORE	●
8	22	57,5	● SUNMORE	●
10	22	57,5	● SUNMORE	●
5	35	70	● SUNMORE	●
6	35	70	● SUNMORE	●
8	35	70	● SUNMORE	●
10	35	70	● SUNMORE	●

■ Utensili non a magazzino, quantità minima d'ordine: 20 pezzi.  
Tools not ready in stock minimum order quantity: 20 pieces.

SPARE PARTS

Type	Dimensions	BRAND
Screw	M5X10	SUNMORE
Screw	M5X17	SUNMORE

Chipboard

RPM	Feed Speed
3000	1 m/min
4000	1,5 m/min
5000	2,0 m/min
6000	2,5 m/min
8000	2,8 m/min

MDF-Wood

RPM	Feed Speed
3000	0,7 m/min
4000	1,0 m/min
5000	1,4 m/min
6000	1,7 m/min
8000	2,0 m/min

The data are indicative only, MW is not responsible for any incorrect application

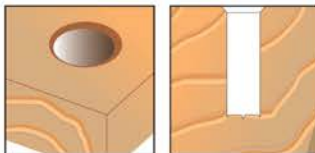
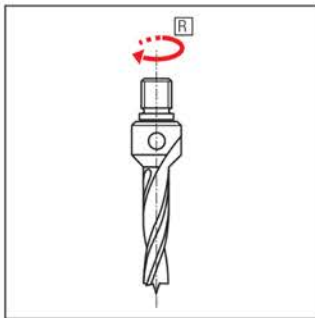
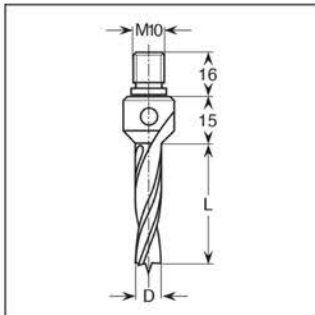

● = Ready in stock   ■ = Delivery time 20 working days   △ = On request

D	L	BRAND	
5	20	● SUNMORE	
6	20	● SUNMORE	
8	20	● SUNMORE	
10	20	● SUNMORE	
12	20	● SUNMORE	
14	20	■ SUNMORE	
5	30	● SUNMORE	
6	30	■ SUNMORE	
8	30	● SUNMORE	
10	30	● SUNMORE	
12	30	● SUNMORE	
14	30	● SUNMORE	
5	40	● SUNMORE	
6	40	● SUNMORE	
8	40	● SUNMORE	
10	40	● SUNMORE	
12	40	● SUNMORE	
14	40	● SUNMORE	
5	50	● SUNMORE	
6	50	● SUNMORE	
8	50	● SUNMORE	
10	50	● SUNMORE	
12	50	● SUNMORE	
14	50	● SUNMORE	

■ Utensili non a magazzino, quantità minima d'ordine: 10 pezzi.  
Tools not ready in stock minimum order quantity: 10 pieces.



MŨI KHOAN TCT - BP

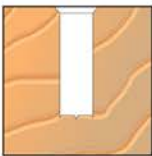
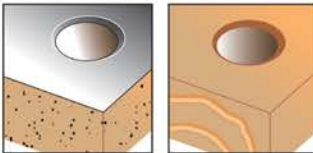
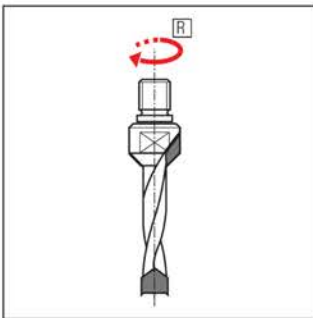
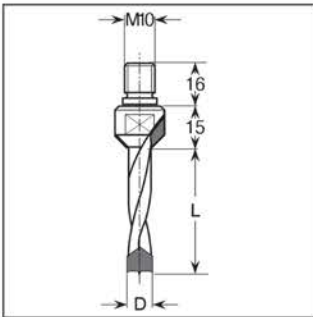

D	L	BRAND		
5	20	● SUNMORE		
6	20	● SUNMORE		
8	20	● SUNMORE		
10	20	● SUNMORE		
12	20	● SUNMORE		
14	20	● SUNMORE		
5	30	● SUNMORE		
6	30	● SUNMORE		
8	30	● SUNMORE		
10	30	● SUNMORE		
12	30	● SUNMORE		
14	30	● SUNMORE		
5	40	● SUNMORE		
6	40	● SUNMORE		
8	40	● SUNMORE		
10	40	● SUNMORE		
12	40	● SUNMORE		
14	40	● SUNMORE		
5	50	● SUNMORE		
6	50	● SUNMORE		
8	50	● SUNMORE		
10	50	● SUNMORE		
12	50	● SUNMORE		
14	50	● SUNMORE		
		SUNMORE		
Spec.		SUNMORE		

● = Ready in stock   ■ = Delivery time 20 working days   △ = On request

■ Utensili non a magazzino, quantità minima d'ordine: 10 pezzi.  
Tools not ready in stock minimum order quantity: 10 pieces.



MŨI KHOAN REN

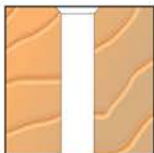
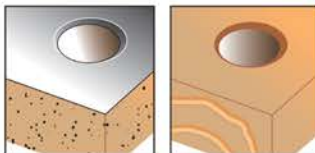
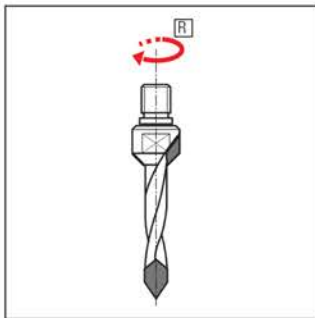
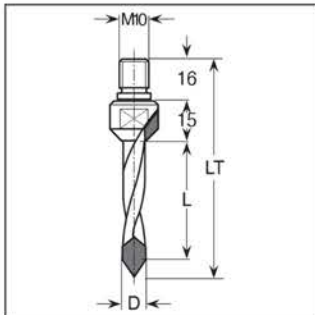

D	L	LT	BRAND
5	20	55	■ SUNMORE
6	20	56	■ SUNMORE
8	20	58	■ SUNMORE
5	30	65	● SUNMORE
6	30	66	■ SUNMORE
8	30	68	● SUNMORE
5	40	75	● SUNMORE
6	40	76	■ SUNMORE
8	40	78	■ SUNMORE
5	50	85	■ SUNMORE
6	50	86	● SUNMORE
8	50	88	● SUNMORE

● = Ready in stock   ■ = Delivery time 20 working days   △ = On request

■ Utensili non a magazzino, quantità minima d'ordine: 10 pezzi.  
Tools not ready in stock minimum order quantity: 10 pieces.



MŨI KHOAN TCT - BP

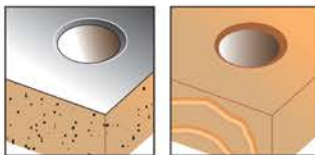
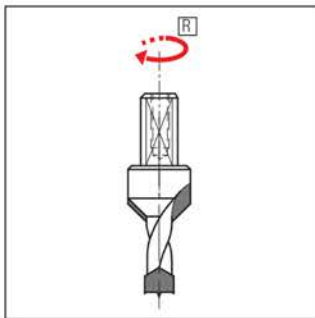
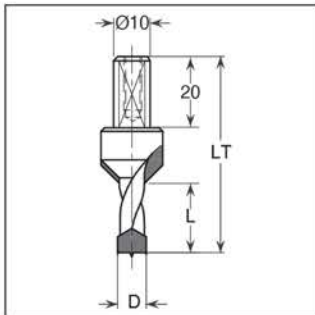

● = Ready in stock   ■ = Delivery time 20 working days   △ = On request

D	L	LT	BRAND
5	12	57,5	● SUNMORE
5	13	57,5	■ SUNMORE
5	15	57,5	■ SUNMORE
5	20	57,5	■ SUNMORE
6	12	57,5	■ SUNMORE
6	13	57,5	■ SUNMORE
6	15	57,5	■ SUNMORE
6	20	57,5	■ SUNMORE
8	12	57,5	● SUNMORE
8	13	57,5	● SUNMORE
8	15	57,5	● SUNMORE
8	20	57,5	● SUNMORE
10	12	57,5	● SUNMORE
10	13	57,5	■ SUNMORE
10	15	57,5	● SUNMORE
10	20	57,5	● SUNMORE
5	12	70	■ SUNMORE
5	13	70	● SUNMORE
5	15	70	■ SUNMORE
5	20	70	■ SUNMORE
5	25	70	■ SUNMORE
6	12	70	● SUNMORE
6	13	70	● SUNMORE
6	15	70	■ SUNMORE
6	20	70	■ SUNMORE
6	25	70	● SUNMORE
8	12	70	● SUNMORE
8	13	70	● SUNMORE
8	15	70	● SUNMORE
8	20	70	■ SUNMORE
8	25	70	● SUNMORE
10	12	70	■ SUNMORE
10	13	70	● SUNMORE
10	15	70	■ SUNMORE
10	20	70	■ SUNMORE
10	25	70	● SUNMORE

■ Utensili non a magazzino, quantità minima d'ordine: 10 pezzi.  
Tools not ready in stock minimum order quantity: 10 pieces.

SPARE PARTS

Type	Dimensions	BRAND
Screw	M5X10	SUNMORE

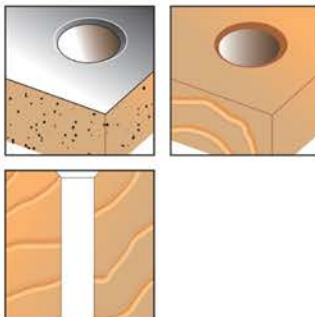
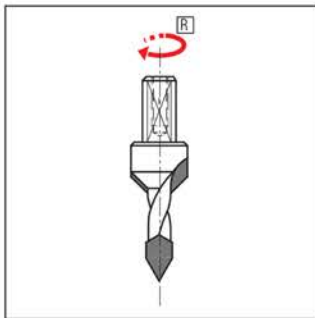
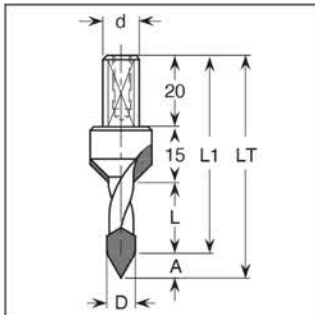

● = Ready in stock   ■ = Delivery time 20 working days   △ = On request

D	L	A	L1	LT	BRAND
5	22,5	4,0	57,5	61,5	● SUNMORE
6	22,5	5,0	57,5	62,5	● SUNMORE
8	22,5	6,5	57,5	64	● SUNMORE
5	35	4,0	70	74	● SUNMORE
6	35	5,0	70	75	● SUNMORE
8	35	6,5	70	76,5	■ SUNMORE
10	35	8,5	70	78,5	● SUNMORE

■ Utensili non a magazzino, quantità minima d'ordine: 10 pezzi.  
Tools not ready in stock minimum order quantity: 10 pieces.

SPARE PARTS

Type	Dimensions	BRAND
Screw	M5X10	SUNMORE

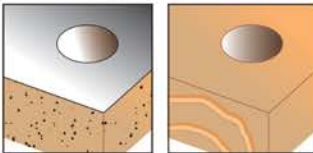
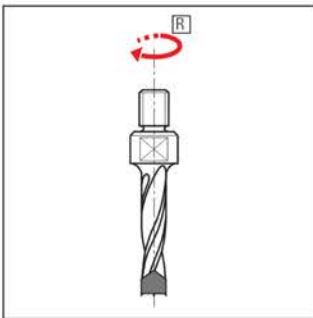
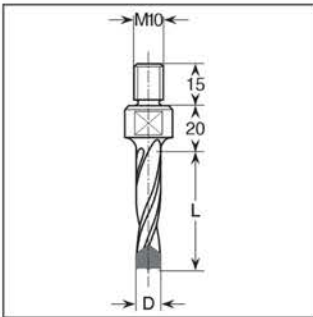

● = Ready in stock   ■ = Delivery time 20 working days   △ = On request

D	L	BRAND		
5	43	● SUNMORE		
6	43	● SUNMORE		
8	43	● SUNMORE		
10	43	■ SUNMORE		
12	43	● SUNMORE		
14	43	● SUNMORE		
8	60	● SUNMORE		
10	60	● SUNMORE		
12	60	■ SUNMORE		
14	60	● SUNMORE		

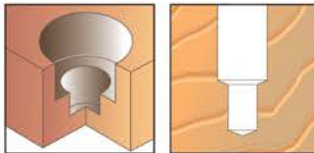
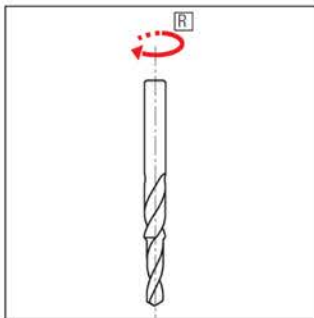
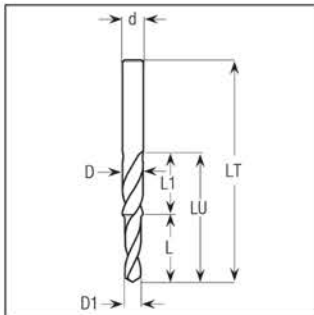

**Z2**

● = Ready in stock ■ = Delivery time 20 working days △ = On request

ANUBA	D1	D	d	L	L1	LULT	BRAND
9,5	3,8	5,2	5,2	18	56	74	△ SUNMORE
11	4,8	5,7	5,7	17	59	76	△ SUNMORE
13	5,8	6,7	6,7	18	65	83	△ SUNMORE
14,5	6,3	7,2	7,2	19	70	89	△ SUNMORE
16	6,7	7,7	7,7	25	75	100	△ SUNMORE
18	7,7	8,7	8,7	25	77	102	△ SUNMORE
20	8,8	9,8	9,8	25	79	104	△ SUNMORE

ANUBA	D1	D	d	L	L1	LULT	BRAND
9	3,8	5	10	20	15	35	△ SUNMORE
11	4,2	5,7	10	20	20	40	△ SUNMORE
13	5,2	6,5	10	15	30	45	△ SUNMORE
14	5,5	7	10	15	35	50	△ SUNMORE
16	6	7,7	10	15	40	55	△ SUNMORE
18	6,6	8,2	10	20	45	65	△ SUNMORE
20	7,2	8,7	10	20	55	75	△ SUNMORE

\* Al momento dell'ordine specificare tutte le dimensioni di costruzione  
 \* When ordering specify all construction sizes

△ Utensili non a magazzino, quantità minima d'ordine: **10 pezzi.**  
 Tools not ready in stock minimum order quantity: **10 pieces.**

## Soft wood

RPM	Feed Speed
3000	1,2 m/min
4000	1,5 m/min
5000	2,0 m/min
6000	2,5 m/min

## Hard wood

RPM	Feed Speed
3000	0,8 m/min
4000	1,0 m/min
5000	1,5 m/min
6000	1,8 m/min

The data are indicative only, MW is not responsible for any incorrect application

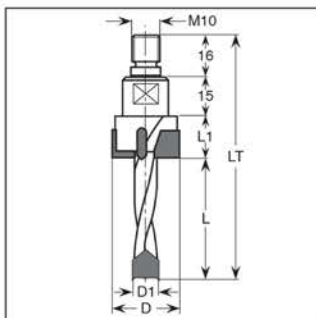

D	LT max		BRAND				
15	120	△	SUNMORE				
20	120	△	SUNMORE				
25	120	△	SUNMORE				
30	120	△	SUNMORE				
40	120	△	SUNMORE				
50	120	△	SUNMORE				

● = Ready in stock   ■ = Delivery time 20 working days   △ = On request

△ Utensili non a magazzino, quantità minima d'ordine: **2 pezzi.**  
 Tools not ready in stock minimum order quantity: **2 pieces.**

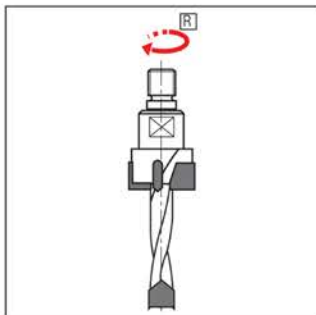

Mod. A

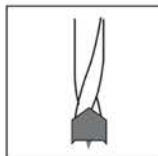

Mod. B

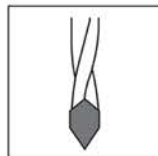

\* In fase di ordine indicare il tipo di esecuzione Mod. A o B  
 \* At the order specify the Mod. A or B

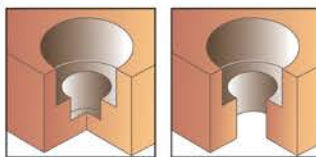
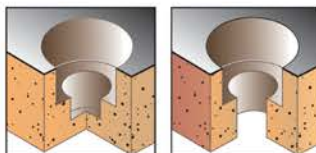

Mod. A



Mod. B

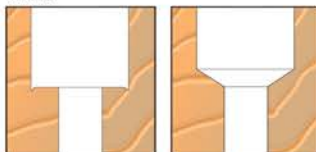

Tutti i marchi presenti sono proprietà dei rispettivi proprietari. All trademarks are the property of their respective holders.

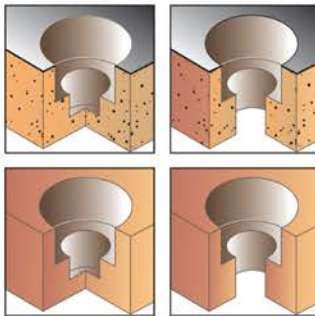
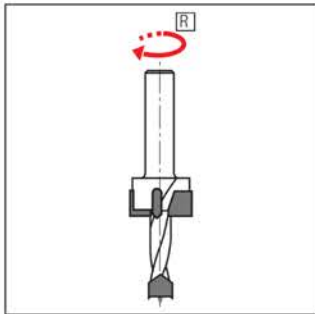
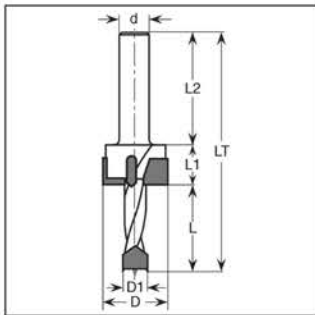

Mod. A

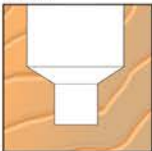

Mod. B

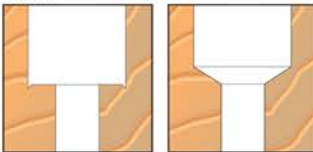

● = Ready in stock   ■ = Delivery time 20 working days   △ = On request

D	LT max	BRAND				
15	120	△ SUNMORE				
20	120	△ SUNMORE				
25	120	△ SUNMORE				
30	120	△ SUNMORE				
40	120	△ SUNMORE				
50	120	△ SUNMORE				

△ Utensili non a magazzino, quantità minima d'ordine: **2 pezzi.**  
*Tools not ready in stock minimum order quantity: 2 pieces.*

Mod. A

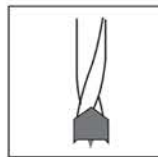

Mod. B

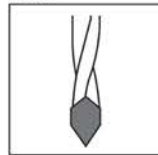

\* In fase di ordine indicare il tipo di esecuzione Mod. A o B  
 \* At the order specify the Mod. A or B

Tutti i marchi presenti sono proprietà dei rispettivi proprietari. All trademarks are the property of their respective holders.

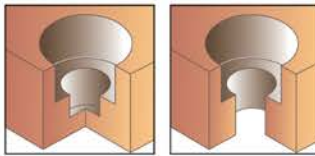
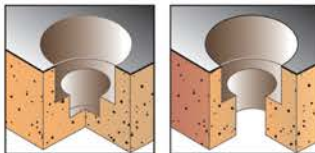
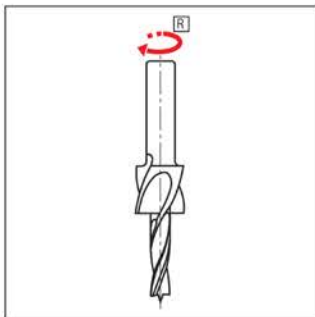
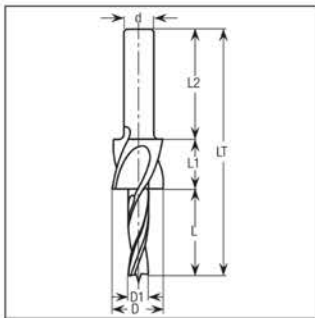

Mod. A

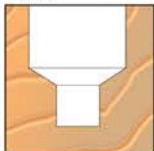

Mod. B

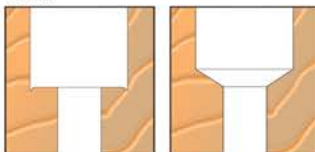

● = Ready in stock   ■ = Delivery time 20 working days   △ = On request

D	LT max	BRAND				
15	120	△ SUNMORE				
20	120	△ SUNMORE				
25	120	△ SUNMORE				
30	120	△ SUNMORE				
40	120	△ SUNMORE				
50	120	△ SUNMORE				

Mod. A



Mod. B

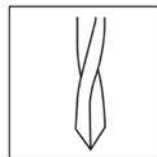

\* In fase di ordine indicare il tipo di esecuzione Mod. A o B  
 \* At the order specify the Mod. A or B

Tutti i marchi presenti sono proprietà dei rispettivi proprietari. All trademarks are the property of their respective holders.

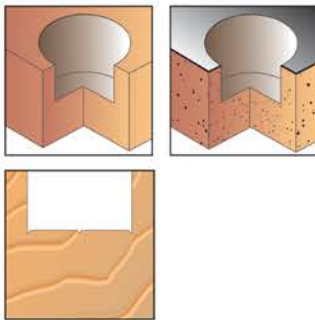
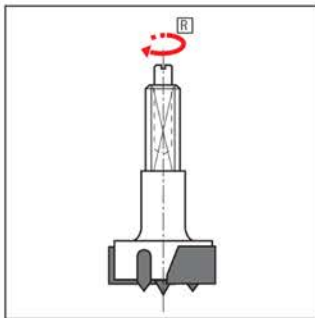
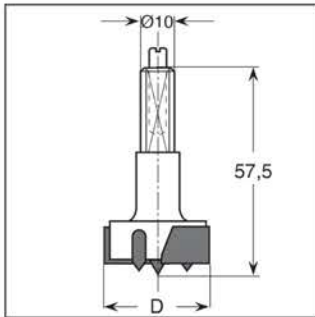

**Z2+2**

● = Ready in stock ■ = Delivery time 20 working days △ = On request

D	BRAND		
14	● SUNMORE		
15	● SUNMORE		
16	● SUNMORE		
18	● SUNMORE		
20	● SUNMORE		
22	● SUNMORE		
25	● SUNMORE		
26	● SUNMORE		
30	● SUNMORE		
35	● SUNMORE		
38	● SUNMORE		
40	● SUNMORE		

■ Utensili non a magazzino, quantità minima d'ordine: **10 pezzi.**  
*Tools not ready in stock minimum order quantity: 10 pieces.*

SPARE PARTS

Type	Dimensions	BRAND	
Screw	M5X10	SUNMORE	
Screw	M5X17	SUNMORE	

Chipboard

RPM	Feed Speed
3000	1 m/min
4000	1,5 m/min
5000	1,8 m/min
6000	2,0 m/min

MDF

RPM	Feed Speed
3000	0,7 m/min
4000	1,0 m/min
5000	1,2 m/min
6000	1,6 m/min

The data are indicative only, MW is not responsible for any incorrect application

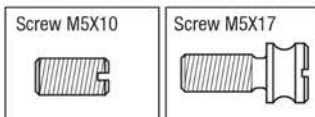

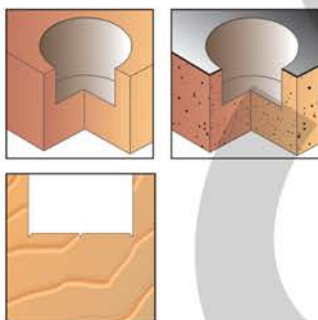
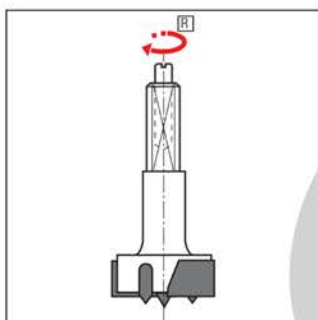
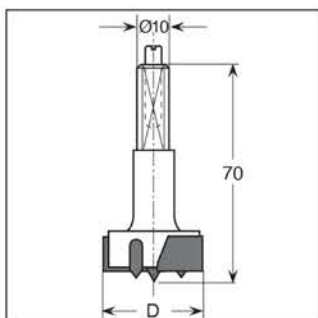

**Z2+2**

● = Ready in stock ■ = Delivery time 20 working days △ = On request

D	BRAND
14	● SUNMORE
15	● SUNMORE
16	● SUNMORE
18	● SUNMORE
20	● SUNMORE
22	● SUNMORE
25	● SUNMORE
26	● SUNMORE
30	● SUNMORE
35	● SUNMORE
38	● SUNMORE
40	● SUNMORE

■ Utensili non a magazzino, quantità minima d'ordine: 10 pezzi.  
Tools not ready in stock minimum order quantity: 10 pieces.

SPARE PARTS

Type	Dimensions	BRAND
Screw	M5X10	SUNMORE
Screw	M5X17	SUNMORE

Chipboard

RPM	Feed Speed
3000	1 m/min
4000	1,5 m/min
5000	1,8 m/min
6000	2,0 m/min

MDF

RPM	Feed Speed
3000	0,7 m/min
4000	1,0 m/min
5000	1,2 m/min
6000	1,6 m/min

The data are indicative only, MW is not responsible for any incorrect application

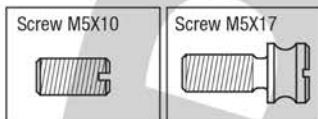

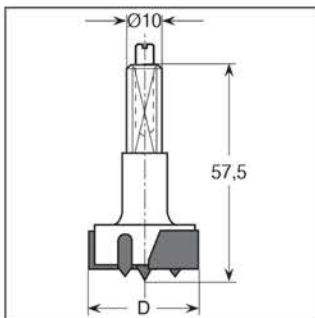

**Z3+3**

● = Ready in stock ■ = Delivery time 20 working days △ = On request

D	BRAND		
25	● SUNMORE		
26	● SUNMORE		
30	● SUNMORE		
35	● SUNMORE		
40	● SUNMORE		

■ Utensili non a magazzino, quantità minima d'ordine: **10 pezzi.**  
*Tools not ready in stock minimum order quantity: 10 pieces.*

SPARE PARTS

Type	Dimensions	BRAND	
Screw	M5X10	SUNMORE	
Screw	M5X17	SUNMORE	

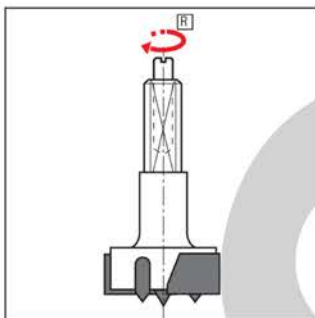

Chipboard

RPM	Feed Speed
3000	1,5 m/min
4000	1,8 m/min
5000	2,0 m/min
6000	2,5 m/min

MDF

RPM	Feed Speed
3000	1,0 m/min
4000	1,2 m/min
5000	1,5 m/min
6000	1,8 m/min

The data are indicative only, MW is not responsible for any incorrect application

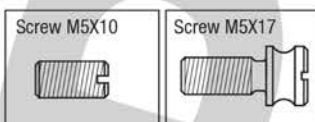
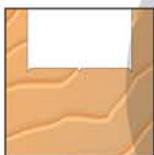
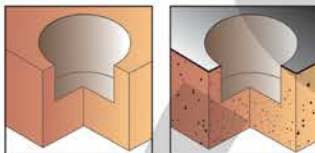

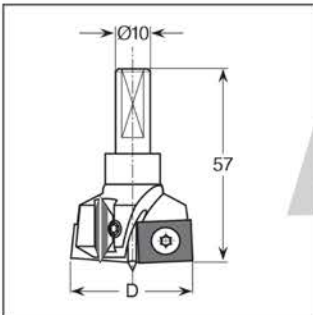

**Z2+2**

● = Ready in stock ■ = Delivery time 20 working days △ = On request

D	BRAND
25	● SUNMORE
26	● SUNMORE
30	● SUNMORE
35	● SUNMORE
40	● SUNMORE

■ Utensili non a magazzino, quantità minima d'ordine: 5 pezzi.  
Tools not ready in stock minimum order quantity: 5 pieces.

SPARE PARTS

Type	Dimensions	BRAND
Knife for D.25	10,6X12X1,5	● SUNMORE
Knife for D.26	11,1X12X1,5	● SUNMORE
Knife for D.30	13,1X12X1,5	● SUNMORE
Knife for D.35	15,6X12X1,5	● SUNMORE
Knife for D.40	18,1X12X1,5	● SUNMORE
Scoring insert	18X6X3,5	● SUNMORE
Center point	3X34	● SUNMORE
Knife screw D.25/30	M3,5X4X7	● SUNMORE
Knife screw D.35/40	M3,5X6,5X7	● SUNMORE
Screw	M3,5X5,5X4	● SUNMORE
Key	T15	● SUNMORE

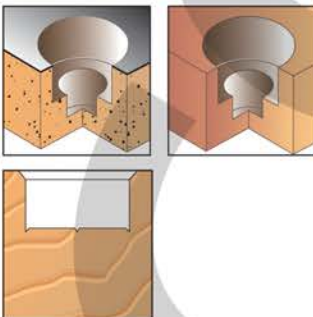
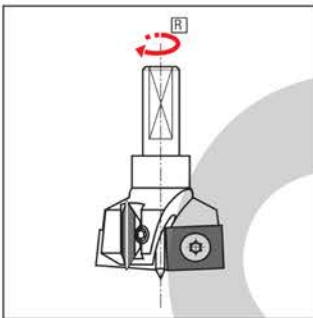

Chipboard

RPM	Feed Speed
3000	1 m/min
4000	1,5 m/min
5000	1,8 m/min
6000	2,0 m/min

MDF

RPM	Feed Speed
3000	0,7 m/min
4000	1,0 m/min
5000	1,2 m/min
6000	1,6 m/min

The data are indicative only, MW is not responsible for any incorrect application



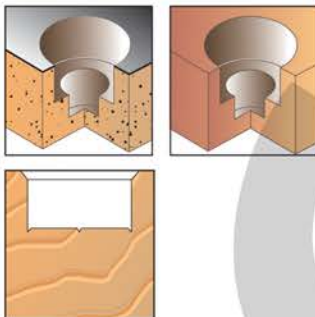
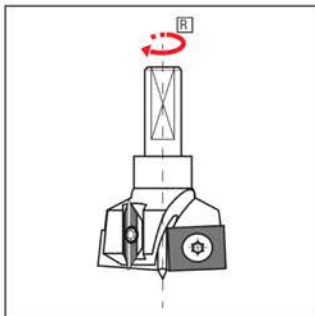
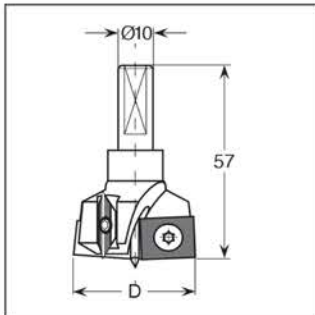

**Z2+2**

● = Ready in stock ■ = Delivery time 20 working days △ = On request

D	BRAND
25	● SUNMORE
26	■ SUNMORE
30	● SUNMORE
35	● SUNMORE
40	● SUNMORE

■ Utensili non a magazzino, quantità minima d'ordine: 5 pezzi.  
Tools not ready in stock minimum order quantity: 5 pieces.

SPARE PARTS

Type	Dimensions	BRAND
Knife for D.25	10X12X1,5	● SUNMORE
Knife for D.26	10,5X12X1,5	● SUNMORE
Knife for D.30	12,5X12X1,5	● SUNMORE
Knife for D.35	15X12X1,5	● SUNMORE
Knife for D.40	18,1X12X1,5	● SUNMORE
Scoring Insert	18,5X8X4	● SUNMORE
Center point	4X34	● SUNMORE
Knife screw D.25/30	M4X4X7	● SUNMORE
Knife screw D.35/40	M4X6X7,2	● SUNMORE
Screw	M4X5,4X6,5	● SUNMORE
Key	T15	● SUNMORE

Chipboard

RPM	Feed Speed
3000	1 m/min
4000	1,5 m/min
5000	1,8 m/min
6000	2,0 m/min

MDF

RPM	Feed Speed
3000	0,7 m/min
4000	1,0 m/min
5000	1,2 m/min
6000	1,6 m/min

The data are indicative only, MW is not responsible for any incorrect application

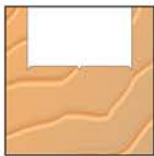
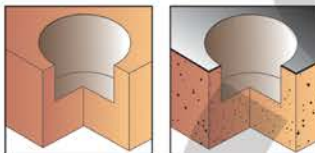
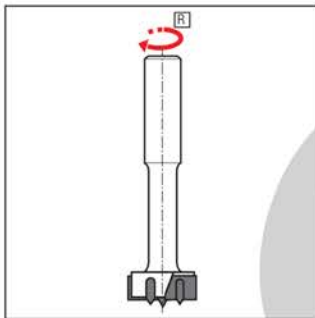
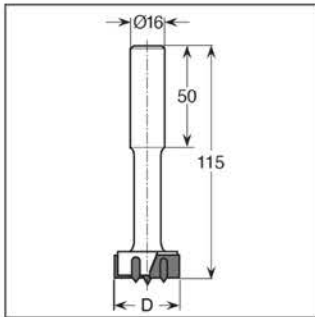

**Z2+2**

● = Ready in stock ■ = Delivery time 20 working days △ = On request

D	BRAND
18	● SUNMORE
20	● SUNMORE
22	● SUNMORE
24	● SUNMORE
25	● SUNMORE
26	● SUNMORE
28	● SUNMORE
30	● SUNMORE
32	● SUNMORE
34	● SUNMORE
35	● SUNMORE
36	● SUNMORE
38	● SUNMORE
40	● SUNMORE

■ Utensili non a magazzino, quantità minima d'ordine: **10 pezzi.**  
 Tools not ready in stock minimum order quantity: **10 pieces.**

Hard wood		Chipboard	
RPM	Feed Speed	RPM	Feed Speed
2000	0,5 m/min	2000	0,6 m/min
3000	0,8 m/min	3000	1 m/min
4000	1 m/min	4000	1,2 m/min

The data are indicative only, MW is not responsible for any incorrect application

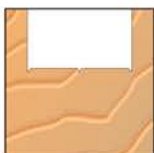
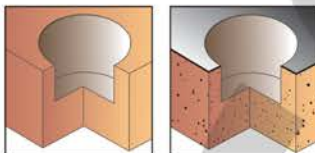
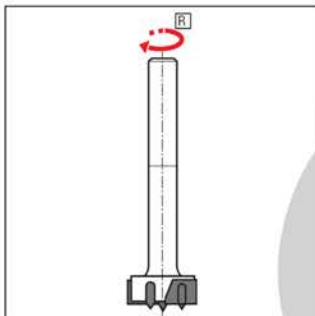
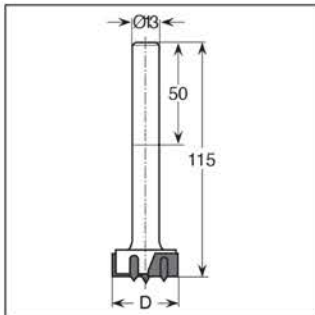

**Z2+2**

● = Ready in stock ■ = Delivery time 20 working days △ = On request

D	BRAND
18	● SUNMORE
20	● SUNMORE
22	● SUNMORE
24	● SUNMORE
25	● SUNMORE
26	● SUNMORE
28	● SUNMORE
30	● SUNMORE
32	● SUNMORE
34	● SUNMORE
35	● SUNMORE
36	● SUNMORE
38	● SUNMORE
40	● SUNMORE

■ Utensili non a magazzino, quantità minima d'ordine: **10 pezzi.**  
*Tools not ready in stock minimum order quantity: 10 pieces.*

Hard wood		Chipboard	
RPM	Feed Speed	RPM	Feed Speed
2000	0,5 m/min	2000	0,6 m/min
3000	0,8 m/min	3000	1 m/min
4000	1 m/min	4000	1,2 m/min

The data are indicative only, MW is not responsible for any incorrect application

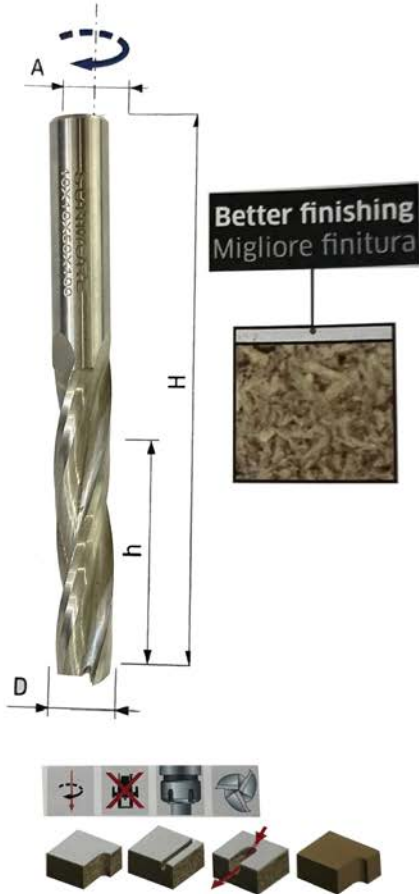

## I. DAO PHAY NGÓN TINH- CẮT LÊN (UP)

STT	TÊN HÀNG HÓA	QUY CÁCH					THƯƠNG HIỆU	TỐC ĐỘ
		D (mm)	h (mm)	A (mm)	H (mm)	Z		
1	Dao phay ngón tinh	3	15-25	6	65	2	SUNMORE	18000-24000
2	Dao phay ngón tinh	4	15-25	6	65	2	SUNMORE	18000-24000
3	Dao phay ngón tinh	5	15-25	6	65	2	SUNMORE	18000-24000
4	Dao phay ngón tinh	6	15-25	6	65	2	SUNMORE	18000-24000
5	Dao phay ngón tinh	6	15-25	6	65	3	SUNMORE	18000-24000
6	Dao phay ngón tinh	8	30-35	8	70	2	SUNMORE	18000-24000
7	Dao phay ngón tinh	8	30-35	8	70	3	SUNMORE	18000-24000
8	Dao phay ngón tinh	10	30-35	10	70	3	SUNMORE	18000-24000
9	Dao phay ngón tinh	12	30-35	12	70	3	SUNMORE	18000-24000
10	Dao phay ngón tinh	8	30-40	8	90	2	SUNMORE	18000-24000
11	Dao phay ngón tinh	8	30-40	8	90	3	SUNMORE	18000-24000
12	Dao phay ngón tinh	10	30-40	10	90	2	SUNMORE	18000-24000
13	Dao phay ngón tinh	10	30-40	10	90	3	SUNMORE	18000-24000
14	Dao phay ngón tinh	12	30-40	12	90	3	SUNMORE	18000-24000
15	Dao phay ngón tinh	12	45-50	12	100	3	SUNMORE	18000-24000
16	Dao phay ngón tinh	12	60	12	120	3	SUNMORE	18000-24000
17	Dao phay ngón tinh	16	50-60	16	120	3	SUNMORE	18000-24000
18	Dao phay ngón tinh	16	90	16	150	3	SUNMORE	18000-24000
19	Dao phay ngón tinh	20	50-60	20	120	3	SUNMORE	18000-24000

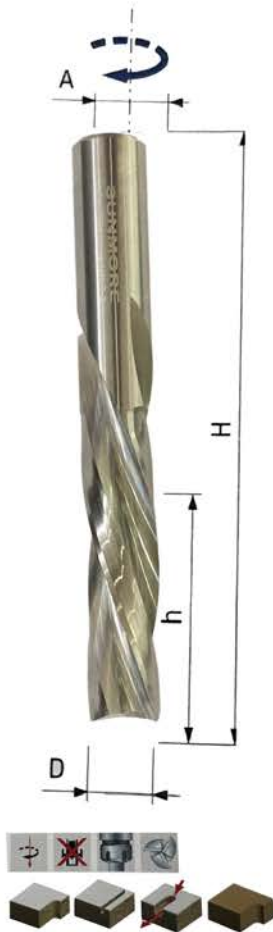

## II. DAO PHAY NGÓN TÍNH- CÁT XUỐNG ( DOWN)

STT	TÊN HÀNG HÓA	QUY CÁCH					THƯƠNG HIỆU	TỐC ĐỘ
		D (mm)	h (mm)	A (mm)	H (mm)	Z		
1	Dao phay ngón tính	3	15-25	6	65	2	SUNMORE	18000-24000
2	Dao phay ngón tính	4	15-25	6	65	2	SUNMORE	18000-24000
3	Dao phay ngón tính	5	15-25	6	65	2	SUNMORE	18000-24000
4	Dao phay ngón tính	6	15-25	6	65	2	SUNMORE	18000-24000
5	Dao phay ngón tính	6	15-25	6	65	3	SUNMORE	18000-24000
6	Dao phay ngón tính	8	30-35	8	70	2	SUNMORE	18000-24000
7	Dao phay ngón tính	8	30-35	8	70	3	SUNMORE	18000-24000
8	Dao phay ngón tính	10	30-35	10	70	3	SUNMORE	18000-24000
9	Dao phay ngón tính	12	30-35	12	70	3	SUNMORE	18000-24000
10	Dao phay ngón tính	8	30-40	8	90	2	SUNMORE	18000-24000
11	Dao phay ngón tính	8	30-40	8	90	3	SUNMORE	18000-24000
12	Dao phay ngón tính	10	30-40	10	90	2	SUNMORE	18000-24000
13	Dao phay ngón tính	10	30-40	10	90	3	SUNMORE	18000-24000
14	Dao phay ngón tính	12	30-40	12	90	3	SUNMORE	18000-24000
15	Dao phay ngón tính	12	45-50	12	100	3	SUNMORE	18000-24000
16	Dao phay ngón tính	12	60	12	120	3	SUNMORE	18000-24000
17	Dao phay ngón tính	16	50-60	16	120	3	SUNMORE	18000-24000
18	Dao phay ngón tính	16	90	16	150	3	SUNMORE	18000-24000
19	Dao phay ngón tính	20	50-60	20	120	3	SUNMORE	18000-24000

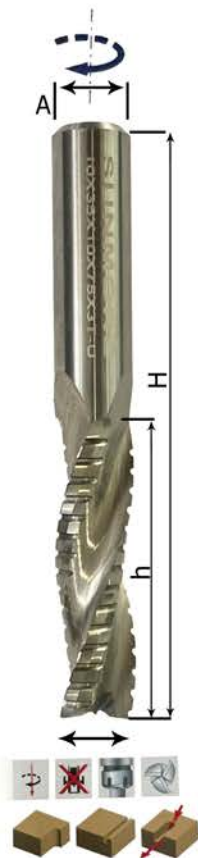

### III. DAO PHAY NGÓN THÔ- CẮT LÊN ( UP)

STT	TÊN HÀNG HÓA	QUY CÁCH					THƯƠNG HIỆU	TỐC ĐỘ
		D (mm)	h (mm)	A (mm)	H (mm)	Z		
1	Dao phay ngón thô	8	30-35	8	70	3	sunmore	18000-24000
2	Dao phay ngón thô	8	30-40	8	90	3	sunmore	18000-24000
3	Dao phay ngón thô	8	30-40	8	90	3	sunmore	18000-24000
4	Dao phay ngón thô	10	30-40	10	90	3	sunmore	18000-24000
5	Dao phay ngón thô	10	30-40	10	90	3	sunmore	18000-24000
6	Dao phay ngón thô	12	30-40	12	90	3	sunmore	18000-24000
7	Dao phay ngón thô	12	35-50	12	100	3	sunmore	18000-24000
8	Dao phay ngón thô	16	50-60	16	120	3	sunmore	18000-24000
9	Dao phay ngón thô	16	60	16	120	3	sunmore	18000-24000
10	Dao phay ngón thô	16	80	16	150	3	sunmore	18000-24000
11	Dao phay ngón thô	20	50-60	20	120	3	sunmore	18000-24000

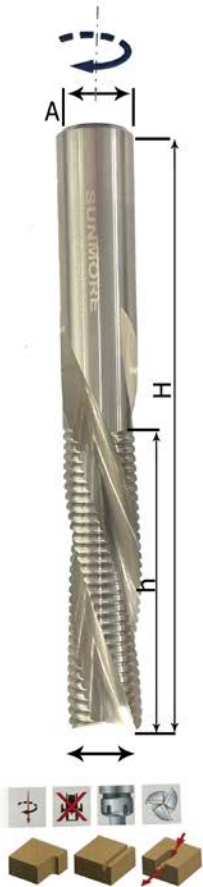

#### IV. DAO PHAY NGÓN THÔ- CẮT XUỐNG ( DOWN)

STT	TÊN HÀNG HÓA	QUY CÁCH					THƯƠNG HIỆU	TỐC ĐỘ
		D (mm)	h (mm)	A (mm)	H (mm)	Z		
1	Dao phay ngón thô	8	30-35	8	70	3	sunmore	18000-24000
2	Dao phay ngón thô	8	30-40	8	90	3	sunmore	18000-24000
3	Dao phay ngón thô	8	30-40	8	90	3	sunmore	18000-24000
4	Dao phay ngón thô	10	30-40	10	90	3	sunmore	18000-24000
5	Dao phay ngón thô	10	30-40	10	90	3	sunmore	18000-24000
6	Dao phay ngón thô	12	30-40	12	90	3	sunmore	18000-24000
7	Dao phay ngón thô	12	35-50	12	100	3	sunmore	18000-24000
8	Dao phay ngón thô	16	50-60	16	120	3	sunmore	18000-24000
9	Dao phay ngón thô	16	60	16	120	3	sunmore	18000-24000
10	Dao phay ngón thô	16	80	16	150	3	sunmore	18000-24000
11	Dao phay ngón thô	20	50-60	20	120	3	sunmore	18000-24000

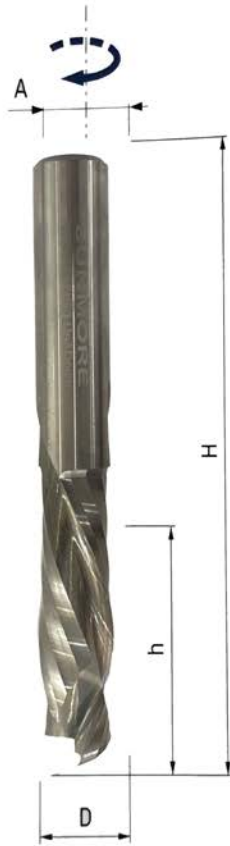

#### IV. FINISHING ROUTER CUTTER – COMBINASION (UP&DOWN)

Serial	Name	Size					Brand	Max RPM
		D (mm)	h (mm)	A (mm)	H (mm)	Z		
1	Dao phay up&down	8	30	8	90	2+2	SUNMORE	18000-24000
2	Dao phay up&down	8	35	8	90	2+2	SUNMORE	18000-24000
3	Dao phay up&down	8	40	8	90	2+2	SUNMORE	18000-24000
4	Dao phay up&down	10	30	10	90	2+2	SUNMORE	18000-24000
5	Dao phay up&down	10	35	10	90	2+2	SUNMORE	18000-24000
6	Dao phay up&down	10	40	10	90	2+2	SUNMORE	18000-24000
7	Dao phay up&down	12	30	12	90	2+2	SUNMORE	18000-24000
8	Dao phay up&down	12	35	12	90	2+2	SUNMORE	18000-24000
9	Dao phay up&down	12	40	12	90	2+2	SUNMORE	18000-24000
10	Dao phay up&down	16	50	16	120	2+2	SUNMORE	18000-24000
11	Dao phay up&down	16	55	16	120	2+2	SUNMORE	18000-24000
12	Dao phay up&down	16	60	16	120	2+2	SUNMORE	18000-24000





### ROUTER CUTTER

Serial	Name	Size				Brand
		A	D	h	z	
1	Router cutter TCT	12/12.7	2	10	2T	SUNMORE
2	Router cutter TCT	12/12.7	3	10	2T	SUNMORE
3	Router cutter TCT	12/12.7	4	15	2T	SUNMORE
4	Router cutter TCT	12/12.7	5	25	2T	SUNMORE
5	Router cutter TCT	12/12.7	6	20	2T	SUNMORE
6	Router cutter TCT	12/12.7	6	25	2T	SUNMORE
7	Router cutter TCT	12/12.7	6	30	2T	SUNMORE
8	Router cutter TCT	12/12.7	8	25	2T	SUNMORE
9	Router cutter TCT	12/12.7	8	30	2T	SUNMORE
10	Router cutter TCT	12/12.7	8	35	2T	SUNMORE
11	Router cutter TCT	12/12.7	8	40	2T	SUNMORE
12	Router cutter TCT	12/12.7	8	45	2T	SUNMORE
13	Router cutter TCT	12/12.7	10	30	2T	SUNMORE
14	Router cutter TCT	12/12.7	10	35	2T	SUNMORE
15	Router cutter TCT	12/12.7	10	40	2T	SUNMORE
16	Router cutter TCT	12/12.7	12	30	2T	SUNMORE
17	Router cutter TCT	12/12.7	12	35	2T	SUNMORE
18	Router cutter TCT	12/12.7	12	40	2T	SUNMORE
19	Router cutter TCT	12/12.7	12	45	2T	SUNMORE
20	Router cutter TCT	12/12.7	12	50	2T	SUNMORE
21	Router cutter TCT	12/12.7	6	20	3T	SUNMORE
22	Router cutter TCT	12/12.7	6	25	3T	SUNMORE
23	Router cutter TCT	12/12.7	6	30	3T	SUNMORE
24	Router cutter TCT	12/12.7	8	25	3T	SUNMORE
25	Router cutter TCT	12/12.7	8	30	3T	SUNMORE
26	Router cutter TCT	12/12.7	8	35	3T	SUNMORE
27	Router cutter TCT	12/12.7	8	40	3T	SUNMORE
28	Router cutter TCT	12/12.7	10	30	3T	SUNMORE
29	Router cutter TCT	12/12.7	10	35	3T	SUNMORE
30	Router cutter TCT	12/12.7	10	40	3T	SUNMORE
31	Router cutter TCT	12/12.7	12	30	3T	SUNMORE



### DAO BÀO XOẮN CHO MÁY BÀO 4 MẶT

Serial	Name	Size				Brand	Note
		D	H	d	Z		
<b>DAO BÀO XOẮN CHO MÁY BÀO 4 MẶT</b>							
1	Dao bào xoắn	125	60	40	6T	SUNMORE	Gắn mảnh 15x15x2.5 - 30 độ ( Ceratizit Luxemburg)
2	Dao bào xoắn	125	80	40	6T	SUNMORE	
3	Dao bào xoắn	125	100	40	6T	SUNMORE	
4	Dao bào xoắn	125	120	40	6T	SUNMORE	
5	Dao bào xoắn	125	150	40	6T	SUNMORE	
6	Dao bào xoắn	125	180	40	6T	SUNMORE	
7	Dao bào xoắn	125	200	40	6T	SUNMORE	
8	Dao bào xoắn	125	230	40	6T	SUNMORE	

Serial	Name	Size				Brand	Note
		D	H	d	Z		
<b>DAO BÀO XOẮN CHO MÁY BÀO 4 MẶT</b>							
1	Dao bào xoắn	125	60	40	6T	SUNMORE	Gắn mảnh 30*12*1,5-35 độ ( Ceratizit Luxemburg)
2	Dao bào xoắn	125	80	40	6T	SUNMORE	
3	Dao bào xoắn	125	100	40	6T	SUNMORE	
4	Dao bào xoắn	125	120	40	6T	SUNMORE	
5	Dao bào xoắn	125	150	40	6T	SUNMORE	
6	Dao bào xoắn	125	180	40	6T	SUNMORE	
7	Dao bào xoắn	125	200	40	6T	SUNMORE	
8	Dao bào xoắn	125	230	40	6T	SUNMORE	





DAO BÀO XOẮN CHO MÁY TUBI							
Serial	Name	Size				Brand	Note
		D	H	d	Z		
DAO BÀO XOẮN MÁY TUBI							
1	Dao bào xoắn	100	60	30	6T	SUNMORE	Gắn mảnh 14*14*2,0 - 30 độ ( Ceratizit Luxemburg)
2	Dao bào xoắn	100	80	30	6T	SUNMORE	
3	Dao bào xoắn	100	100	30	6T	SUNMORE	
4	Dao bào xoắn	100	120	30	6T	SUNMORE	
5	Dao bào xoắn	100	150	30	6T	SUNMORE	

**TRỤC DAO BÀO XOẮN CHO MÁY BÀO 2 MẶT**

Serial	Name	Size	Q'ty	Price	Brand	Note
<b>TRỤC DAO BÀO XOẮN CHO MÁY BÀO 2 MẶT</b>						
1	Dao bào xoắn	100x300x6T	1	Liên hệ	SUNMORE	Gắn mảnh 15x15x2.5 - 30 độ ( Ceratizit Luxemburg)
2	Dao bào xoắn	100x400x6T	1	Liên hệ	SUNMORE	
3	Dao bào xoắn	100x510x6T	1	Liên hệ	SUNMORE	
4	Dao bào xoắn	100x610x6T	1	Liên hệ	SUNMORE	
5	Dao bào xoắn	125x510x6T	1	Liên hệ	SUNMORE	
6	Dao bào xoắn	125x610x6T	1	Liên hệ	SUNMORE	







**HOTLINE: 0982 109 076**

**SUNMORE<sup>®</sup>**

GERMANY STANDARD  
CARBIDE TIPPED SAW

***AN BINH SAW BLADE CO., LTD***

**Add: 14, An Phu 35 Street, Binh Chuan Ward,  
Thuan An City, Binh Duong Province.**

**Website: [www.luoicuasunmore.com.vn](http://www.luoicuasunmore.com.vn) – [www.sunmore.com.vn](http://www.sunmore.com.vn)**

**TEL: +84 274 3764494**

**E-mail: [anbinhsaw@gmail.com](mailto:anbinhsaw@gmail.com)**